



IKHMAS JAYA GROUP BERHAD

億馬建築集團有限公司

No. 35, 37 & 39, Jalan PJU 1A/41B
Pusat Dagangan NZX, 47301 Petaling Jaya
Selangor, Malaysia.

Tel : 60 3-7885 0612
Fax : 60 3-7885 0720
Email : info@ikhmasjaya.com.my

PROSPECTUS



IKHMAS JAYA GROUP BERHAD
億馬建築集團有限公司

THIS PROSPECTUS IS DATED 30 JUNE 2015

PROSPECTUS



IKHMAS JAYA GROUP BERHAD

(Company No. 1072872-D)
(Incorporated in Malaysia under the Companies Act, 1965)

INITIAL PUBLIC OFFERING OF 182,000,000 ORDINARY SHARES OF RM0.25 EACH IN IKHMAS JAYA GROUP BERHAD ("SHARES") IN THE FOLLOWING MANNER:-

- (A) PUBLIC ISSUE OF 126,000,000 NEW SHARES COMPRISING:-
- 26,000,000 NEW SHARES AVAILABLE FOR APPLICATION BY THE MALAYSIAN PUBLIC;
 - 26,000,000 NEW SHARES AVAILABLE FOR APPLICATION BY THE ELIGIBLE DIRECTORS, EMPLOYEES AND BUSINESS ASSOCIATES OF IKHMAS JAYA GROUP BERHAD AND ITS SUBSIDIARIES; AND
 - 74,000,000 NEW SHARES AVAILABLE FOR APPLICATION BY WAY OF PRIVATE PLACEMENT TO SELECTED INVESTORS;

AND

- (B) OFFER FOR SALE OF 56,000,000 SHARES COMPRISING:-
- 52,000,000 SHARES AVAILABLE FOR APPLICATION BY WAY OF PRIVATE PLACEMENT TO SELECTED BUMIPUTERA INVESTORS APPROVED BY THE MINISTRY OF INTERNATIONAL TRADE AND INDUSTRY; AND
 - 4,000,000 SHARES AVAILABLE FOR APPLICATION BY WAY OF PRIVATE PLACEMENT TO SELECTED INVESTORS;

AT AN ISSUE/ OFFER PRICE OF RM0.57 PER SHARE PAYABLE IN FULL ON APPLICATION IN CONJUNCTION WITH THE LISTING OF IKHMAS JAYA GROUP BERHAD ON THE MAIN MARKET OF BURSA MALAYSIA SECURITIES BERHAD

Principal Adviser, Underwriter and Placement Agent



AmInvestment Bank

AmInvestment Bank Berhad
(Company No. 23742-V)

(A Participating Organisation of Bursa Malaysia Securities Berhad)

INVESTORS ARE ADVISED TO READ AND UNDERSTAND THE CONTENTS OF THE PROSPECTUS. IF IN DOUBT, PLEASE CONSULT A PROFESSIONAL ADVISER.

THERE ARE CERTAIN RISK FACTORS WHICH PROSPECTIVE INVESTORS SHOULD CONSIDER. REFER TO SECTION 3 OF THIS PROSPECTUS FOR "RISK FACTORS".

RESPONSIBILITY STATEMENTS

THE DIRECTORS AND PROMOTERS OF THE COMPANY AND THE OFFEROR HAVE SEEN AND APPROVED THIS PROSPECTUS. THEY COLLECTIVELY AND INDIVIDUALLY ACCEPT FULL RESPONSIBILITY FOR THE ACCURACY OF THE INFORMATION. HAVING MADE ALL REASONABLE ENQUIRIES AND TO THE BEST OF THEIR KNOWLEDGE AND BELIEF, THEY CONFIRM THERE IS NO FALSE OR MISLEADING STATEMENT OR OTHER FACTS WHICH IF OMITTED, WOULD MAKE ANY STATEMENT IN THIS PROSPECTUS FALSE OR MISLEADING.

AmlINVESTMENT BANK BERHAD, BEING THE PRINCIPAL ADVISER, UNDERWRITER AND PLACEMENT AGENT ACKNOWLEDGES THAT, BASED ON ALL AVAILABLE INFORMATION, AND TO THE BEST OF ITS KNOWLEDGE AND BELIEF, THIS PROSPECTUS CONSTITUTES A FULL AND TRUE DISCLOSURE OF ALL MATERIAL FACTS CONCERNING THE INITIAL PUBLIC OFFERING ("IPO").

STATEMENTS OF DISCLAIMER

THE SECURITIES COMMISSION MALAYSIA ("SC") HAS APPROVED THE IPO AND A COPY OF THIS PROSPECTUS HAS BEEN REGISTERED WITH THE SC. THE APPROVAL, AND REGISTRATION OF THIS PROSPECTUS, SHOULD NOT BE TAKEN TO INDICATE THAT THE SC RECOMMENDS THE IPO OR ASSUMES RESPONSIBILITY FOR THE CORRECTNESS OF ANY STATEMENT MADE OR OPINION OR REPORT EXPRESSED IN THIS PROSPECTUS. THE SC HAS NOT, IN ANY WAY, CONSIDERED THE MERITS OF THE SECURITIES BEING OFFERED FOR INVESTMENT.

THE SC IS NOT LIABLE FOR ANY NON-DISCLOSURE ON THE PART OF THE COMPANY AND TAKES NO RESPONSIBILITY FOR THE CONTENTS OF THIS PROSPECTUS, MAKES NO REPRESENTATION AS TO ITS ACCURACY OR COMPLETENESS, AND EXPRESSLY DISCLAIMS ANY LIABILITY FOR ANY LOSS YOU MAY SUFFER ARISING FROM OR IN RELIANCE UPON THE WHOLE OR ANY PART OF THE CONTENTS OF THIS PROSPECTUS.

INVESTORS SHOULD RELY ON THEIR OWN EVALUATION TO ASSESS THE MERITS AND RISKS OF THE INVESTMENT. INVESTORS WHO ARE IN ANY DOUBT AS TO THE ACTION TO BE TAKEN SHOULD CONSULT THEIR STOCKBROKERS, BANK MANAGERS, SOLICITORS, ACCOUNTANTS OR OTHER PROFESSIONAL ADVISERS IMMEDIATELY.

THE VALUATION UTILISED FOR THE PURPOSE OF THE CORPORATE EXERCISE SHOULD NOT BE CONSTRUED AS AN ENDORSEMENT BY THE SC ON THE VALUE OF THE SUBJECT ASSETS.

APPROVAL HAS BEEN OBTAINED FROM BURSA MALAYSIA SECURITIES BERHAD ("**BURSA SECURITIES**") FOR THE LISTING OF AND QUOTATION FOR THE SECURITIES BEING OFFERED. ADMISSION TO THE OFFICIAL LIST OF BURSA SECURITIES IS NOT TO BE TAKEN AS AN INDICATION OF THE MERITS OF THE IPO, OUR COMPANY OR ITS SECURITIES.

BURSA SECURITIES IS NOT LIABLE FOR ANY NON-DISCLOSURE ON THE PART OF THE COMPANY AND TAKES NO RESPONSIBILITY FOR THE CONTENTS OF THIS PROSPECTUS, MAKES NO REPRESENTATION AS TO ITS ACCURACY OR COMPLETENESS, AND EXPRESSLY DISCLAIMS ANY LIABILITY FOR ANY LOSS YOU MAY SUFFER ARISING FROM OR IN RELIANCE UPON THE WHOLE OR ANY PART OF THE CONTENTS OF THIS PROSPECTUS.

A COPY OF THIS PROSPECTUS, TOGETHER WITH THE APPLICATION FORM, HAS ALSO BEEN LODGED WITH THE REGISTRAR OF COMPANIES WHO TAKES NO RESPONSIBILITY FOR ITS CONTENTS.

OTHER STATEMENTS

INVESTORS ARE ADVISED TO NOTE THAT RECOURSE FOR FALSE OR MISLEADING STATEMENTS OR ACTS MADE IN CONNECTION WITH THE PROSPECTUS IS DIRECTLY AVAILABLE THROUGH SECTIONS 248, 249 AND 357 OF THE CAPITAL MARKETS AND SERVICES ACT 2007 ("**CMSA**").

AVAILABLE THROUGH SECTIONS 248, 249 AND 357 OF THE CAPITAL MARKETS AND SERVICES ACT 2007 ("CMSA").

SECURITIES LISTED ON BURSA SECURITIES ARE OFFERED TO THE PUBLIC PREMISED ON FULL AND ACCURATE DISCLOSURE OF ALL MATERIAL INFORMATION CONCERNING THE IPO FOR WHICH ANY OF THE PERSONS SET OUT IN SECTION 236 OF THE CMSA, E.G. DIRECTORS AND ADVISERS, ARE RESPONSIBLE.

THE SECURITIES OF THIS COMPANY IS CLASSIFIED AS SHARIAH COMPLIANT BY THE SHARIAH ADVISORY COUNCIL OF THE SC BASED ON THE LATEST AUDITED FINANCIAL YEAR ENDED 31 DECEMBER 2014. THIS CLASSIFICATION REMAINS VALID FROM THE DATE OF ISSUE OF THE PROSPECTUS UNTIL THE NEXT SHARIAH COMPLIANCE REVIEW UNDERTAKEN BY THE SHARIAH ADVISORY COUNCIL OF THE SC. THE NEW STATUS IS RELEASED IN THE UPDATED LIST OF SHARIAH-COMPLIANT SECURITIES, ON THE LAST FRIDAY OF MAY AND NOVEMBER.

THIS PROSPECTUS HAS NOT BEEN AND WILL NOT BE MADE TO COMPLY WITH THE LAWS OF ANY JURISDICTION OTHER THAN MALAYSIA. THIS PROSPECTUS HAS NOT BEEN AND WILL NOT BE LODGED, REGISTERED OR APPROVED PURSUANT TO OR UNDER ANY APPLICABLE SECURITIES OR EQUIVALENT LEGISLATION OR WITH OR BY ANY REGULATORY AUTHORITY OR OTHER RELEVANT BODY OF ANY JURISDICTION OTHER THAN MALAYSIA.

NO ACTION HAS BEEN OR WILL BE TAKEN TO ENSURE THAT THIS PROSPECTUS COMPLIES WITH THE LAWS OF ANY COUNTRIES OR JURISDICTION OTHER THAN THE LAWS OF MALAYSIA. IT SHALL BE YOUR SOLE RESPONSIBILITY TO CONSULT YOUR LEGAL AND/OR OTHER PROFESSIONAL ADVISERS ON THE LAWS TO WHICH THE IPO OR YOU ARE OR MAY BE SUBJECTED TO. NEITHER WE NOR THE PRINCIPAL ADVISER NOR ANY OTHER ADVISERS IN RELATION TO THE IPO SHALL ACCEPT ANY RESPONSIBILITY OR LIABILITY IN THE EVENT THAT ANY APPLICATION MADE BY YOU SHALL BECOME ILLEGAL, UNENFORCEABLE, VOIDABLE OR VOID IN ANY COUNTRY OR JURISDICTION.

THE CIRCULATION OF THIS PROSPECTUS AND THE IPO MAY BE RESTRICTED IN CERTAIN JURISDICTIONS OUTSIDE MALAYSIA AND THEREFORE PERSONS WHO MAY BE IN POSSESSION OF THIS PROSPECTUS ARE REQUIRED TO INFORM THEMSELVES, SEEK ADVICE ON AND OBSERVE ANY SUCH RESTRICTIONS. THIS PROSPECTUS MAY NOT BE USED FOR PURPOSE OF AND DOES NOT CONSTITUTE AN ISSUE, OFFER OR INVITATION FOR THE IPO BY ANYONE IN ANY JURISDICTION IN WHICH SUCH ISSUE, OFFER OR INVITATION IS NOT AUTHORISED OR LAWFUL OR TO ANY PERSON TO WHOM IT IS UNLAWFUL TO MAKE SUCH ISSUE, OFFER OR INVITATION.

IT SHALL BE YOUR SOLE RESPONSIBILITY IF YOU ARE OR MAY BE SUBJECTED TO THE LAWS OF COUNTRIES OR JURISDICTIONS OTHER THAN MALAYSIA TO CONSULT YOUR LEGAL AND/OR OTHER PROFESSIONAL ADVISERS AS TO WHETHER THE IPO WOULD RESULT IN THE CONTRAVENTION OF ANY LAWS OF SUCH COUNTRIES OR JURISDICTIONS.

FURTHER, IT SHALL ALSO BE YOUR SOLE RESPONSIBILITY TO ENSURE THAT YOUR APPLICATION FOR THE IPO WOULD BE IN COMPLIANCE WITH THE TERMS OF THE IPO AND WOULD NOT BE IN CONTRAVENTION OF ANY LAWS OF COUNTRIES OR JURISDICTIONS OTHER THAN MALAYSIA TO WHICH YOU MAY BE SUBJECTED TO. WE WILL FURTHER ASSUME THAT YOU HAD RECEIVED THIS PROSPECTUS AND ACCEPTED THIS IPO IN MALAYSIA AND WILL AT ALL APPLICABLE TIMES BE SUBJECTED ONLY TO THE LAWS OF MALAYSIA IN CONNECTION THEREWITH.

WE WILL NOT, PRIOR TO ACTING ON ANY ACCEPTANCE IN RESPECT OF THE IPO, MAKE OR BE BOUND TO MAKE ANY ENQUIRY AS TO WHETHER YOU HAVE AN ADDRESS IN MALAYSIA AND WILL NOT ACCEPT OR BE DEEMED TO ACCEPT ANY LIABILITY IN RELATION THERETO WHETHER OR NOT ANY ENQUIRY OR INVESTIGATION IS MADE IN CONNECTION THEREWITH.

HOWEVER, WE RESERVE THE RIGHT, IN OUR ABSOLUTE DISCRETION TO TREAT ANY ACCEPTANCE AS INVALID IF WE BELIEVE THAT SUCH ACCEPTANCE MAY VIOLATE ANY LAW OR APPLICABLE LEGAL OR REGULATORY REQUIREMENTS.

ELECTRONIC PROSPECTUS

THIS PROSPECTUS CAN ALSO BE VIEWED OR DOWNLOADED FROM BURSA SECURITIES' WEBSITE AT <http://www.bursamalaysia.com>. THE CONTENTS OF THE ELECTRONIC PROSPECTUS AND THE COPY OF THIS PROSPECTUS REGISTERED WITH THE SC ARE THE SAME.

YOU MAY ALSO OBTAIN A COPY OF THE ELECTRONIC PROSPECTUS FROM THE WEBSITE OF CIMB INVESTMENT BANK BERHAD AT <http://www.eipocimb.com>, CIMB BANK BERHAD AT <http://www.cimbclicks.com.my>, MALAYAN BANKING BERHAD AT <http://www.maybank2u.com.my>, RHB BANK BERHAD AT <http://www.rhbgroup.com>, AFFIN HWANG INVESTMENT BANK BERHAD AT <http://www.affintrade.com> AND PUBLIC BANK BERHAD AT <http://www.pbe.com> VIA HYPERLINK TO THE WEBSITE OF BURSA SECURITIES.

THE INTERNET IS NOT A FULLY SECURE MEDIUM. INTERNET APPLICATIONS MAY BE SUBJECT TO RISKS IN DATA TRANSMISSION, COMPUTER SECURITY THREATS SUCH AS VIRUSES, HACKERS AND CRACKERS, FAULTS WITH COMPUTER SOFTWARE AND OTHER EVENTS BEYOND THE CONTROL OF THE INTERNET PARTICIPATING FINANCIAL INSTITUTIONS (AS DEFINED HEREINAFTER). THESE RISKS CANNOT BE BORNE BY THE INTERNET PARTICIPATING FINANCIAL INSTITUTIONS.

IF YOU ARE IN DOUBT ABOUT THE VALIDITY OR INTEGRITY OF AN ELECTRONIC PROSPECTUS, YOU SHOULD IMMEDIATELY REQUEST FROM US, OUR PRINCIPAL ADVISER OR MALAYSIAN ISSUING HOUSE SDN BHD ("**ISSUING HOUSE**" OR "**MIH**") A PAPER/ PRINTED COPY OF THIS PROSPECTUS. IF THERE IS ANY DISCREPANCY BETWEEN THE CONTENTS OF THE ELECTRONIC PROSPECTUS AND THE PAPER/ PRINTED COPY OF THIS PROSPECTUS, THE CONTENTS OF THE PAPER/ PRINTED COPY OF THIS PROSPECTUS, WHICH ARE IDENTICAL TO THE COPY OF THIS PROSPECTUS REGISTERED WITH THE SC, SHALL PREVAIL.

IN RELATION TO ANY REFERENCE IN THIS PROSPECTUS TO THIRD PARTY INTERNET SITES (REFERRED TO AS "**THIRD PARTY INTERNET SITES**") WHETHER BY WAY OF HYPERLINKS OR BY WAY OF DESCRIPTION OF THE THIRD PARTY INTERNET SITES, INVESTORS ACKNOWLEDGE AND AGREE THAT:-

- (I) WE DO NOT ENDORSE AND ARE NOT AFFILIATED IN ANY WAY TO THE THIRD PARTY INTERNET SITES. ACCORDINGLY, WE ARE NOT RESPONSIBLE FOR THE AVAILABILITY OF, THE CONTENT ON, OR ANY DATA, FILES OR OTHER MATERIAL PROVIDED ON THE THIRD PARTY INTERNET SITES. YOU SHALL BEAR ALL RISKS ASSOCIATED WITH THE ACCESS TO OR USE OF THE THIRD PARTY INTERNET SITES;
- (II) WE ARE NOT RESPONSIBLE FOR THE QUALITY OF PRODUCTS OR SERVICES IN THE THIRD PARTY INTERNET SITES, PARTICULARLY IN FULFILLING ANY OF THE TERMS OF ANY OF YOUR AGREEMENTS WITH THE THIRD PARTY INTERNET SITES. WE ARE ALSO NOT RESPONSIBLE FOR ANY LOSS OR DAMAGE OR COST THAT YOU MAY SUFFER OR INCUR IN CONNECTION WITH OR AS A RESULT OF DEALING WITH THE THIRD PARTY INTERNET SITES OR THE USE OF OR RELIANCE ON ANY DATA, FILES OR OTHER MATERIAL PROVIDED BY SUCH PARTIES; AND
- (III) ANY DATA FILE OR OTHER MATERIAL DOWNLOADED FROM THE THIRD PARTY INTERNET SITES IS DONE AT YOUR DISCRETION AND RISK. WE ARE NOT RESPONSIBLE, LIABLE OR UNDER OBLIGATION FOR ANY DAMAGE TO YOUR COMPUTER SYSTEM OR LOSS OF DATA RESULTING FROM THE DOWNLOADING OF ANY SUCH DATA, INFORMATION, FILES OR OTHER MATERIAL.

WHERE AN ELECTRONIC PROSPECTUS IS HOSTED ON THE WEBSITE OF THE INTERNET PARTICIPATING FINANCIAL INSTITUTION, YOU ARE ADVISED THAT:-

- (I) THE INTERNET PARTICIPATING FINANCIAL INSTITUTION IS ONLY LIABLE IN RESPECT OF THE INTEGRITY OF THE CONTENTS OF THE ELECTRONIC PROSPECTUS, I.E. TO THE EXTENT THAT THE CONTENTS OF THE ELECTRONIC PROSPECTUS ON THE WEB SERVER OF THE INTERNET PARTICIPATING FINANCIAL INSTITUTION MAY BE VIEWED VIA WEB BROWSER OR OTHER RELEVANT SOFTWARE. THE INTERNET PARTICIPATING FINANCIAL INSTITUTION IS NOT RESPONSIBLE FOR THE INTEGRITY OF THE CONTENTS OF THE ELECTRONIC PROSPECTUS, WHICH HAS BEEN OBTAINED FROM THE WEB SERVER OF THE INTERNET PARTICIPATING FINANCIAL INSTITUTION AND SUBSEQUENTLY COMMUNICATED OR DISSEMINATED IN ANY MANNER TO YOU OR OTHER PARTIES; AND
- (II) WHILE ALL REASONABLE MEASURES HAVE BEEN TAKEN TO ENSURE THE ACCURACY AND RELIABILITY OF THE INFORMATION PROVIDED IN THE ELECTRONIC PROSPECTUS, THE ACCURACY AND RELIABILITY OF THE ELECTRONIC PROSPECTUS CANNOT BE GUARANTEED BECAUSE THE INTERNET IS NOT A FULLY SECURED MEDIUM.

THE INTERNET PARTICIPATING FINANCIAL INSTITUTION IS NOT LIABLE (WHETHER IN TORT OR CONTRACT OR OTHERWISE) FOR ANY LOSS, DAMAGE OR COSTS, YOU OR ANY OTHER PERSON MAY SUFFER OR INCUR DUE TO, AS A CONSEQUENCE OF OR IN CONNECTION WITH ANY INACCURACIES, CHANGES, ALTERATIONS, DELETIONS OR OMISSIONS IN RESPECT OF THE INFORMATION PROVIDED IN THE ELECTRONIC PROSPECTUS WHICH MAY ARISE IN CONNECTION WITH OR AS A RESULT OF ANY FAULT WITH WEB BROWSERS OR OTHER RELEVANT SOFTWARE, ANY FAULT ON YOUR OR ANY THIRD PARTY'S PERSONAL COMPUTER, OPERATING SYSTEM OF OTHER SOFTWARE, VIRUSES OR OTHER SECURITY THREATS, UNAUTHORISED ACCESS TO INFORMATION OR SYSTEMS IN RELATION TO THE WEBSITE OF THE INTERNET PARTICIPATING FINANCIAL INSTITUTION, AND/OR PROBLEMS OCCURRING DURING DATA TRANSMISSION WHICH MAY RESULT IN INACCURATE OR INCOMPLETE COPIES OF INFORMATION BEING DOWNLOADED OR DISPLAYED ON YOUR PERSONAL COMPUTER.

[THE REST OF THIS PAGE IS INTENTIONALLY LEFT BLANK]

TABLE OF CONTENTS

	Page
Indicative Timetable	i
Definitions	ii
Glossary of Technical Terms	viii
Presentation of Information	x
Forward Looking Statements	xi
Corporate Directory	xiii
1. Information Summary	1
1.1 History and Business	1
1.2 Competitive Advantages and Key Strengths	3
1.3 Promoters, Substantial Shareholders, Directors and Key Management of Our Group	3
1.4 Proforma Consolidated Statement of Profit or Loss and Other Comprehensive Income	4
1.5 Proforma Consolidated Statement of Financial Position	5
1.6 Principal Statistics Relating to the IPO	6
1.7 Utilisation of Proceeds	7
1.8 Risk Factors	7
1.9 Audit Qualifications	8
1.10 Shariah Status	8
2. Particulars of the IPO	9
2.1 Purposes of the IPO	10
2.2 Share Capital	11
2.3 Details of the IPO	12
2.4 Basis of Arriving at the IPO Price	16
2.5 Market Capitalisation Upon Listing	17
2.6 Dilution	17
2.7 Utilisation of Proceeds	18
2.8 Financial Impact from Utilisation of Proceeds	21
2.9 Underwriting Commission, Placement Fee and Brokerage	22
2.10 Salient Terms of the Underwriting Agreement	22
3. Risk Factors	25
3.1 Risks Relating to Our Business and Operations	25
3.2 Risks Relating to the Industry in Which Our Group Operates	34
3.3 Risks Relating to the IPO	36
4. Information on Our Group	39
4.1 Background Information	39
4.2 Listing Scheme	50
4.3 Overview of Our Group's Business Model and Overall Strategy	53
4.4 Awards, Recognition and Affiliations	57
4.5 Overview of Our Group's Business Activities	58
4.6 Our Business and Operation Processes	79
4.7 Quality Assurance Management	82
4.8 R&D	82
4.9 Technology Used	83
4.10 Raw Materials and Major Suppliers	89

TABLE OF CONTENTS (Cont'd)

4.11	Marketing Activities and Major Customers	91
4.12	Seasonality.....	95
4.13	Brands Names, Trade Marks, Licence Agreements and Technical Agreements	95
4.14	Our Group's Property, Plant and Equipment	96
4.15	Approvals, Major Licences and Permits	108
4.16	Dependency on Contracts/ Arrangements/ Licences/ Patents	125
4.17	Interruptions in Business for the Past Twelve (12) Months	125
4.18	Future Plans, Strategies and Prospects	125
5.	Independent Market Research Report	130
6.	Information on Promoters, Substantial Shareholders, Directors and Key Management	175
6.1	Promoters and Substantial Shareholders	175
6.2	Directors.....	180
6.3	Board Practices.....	189
6.4	Key Management.....	192
6.5	Declaration of Promoters, Directors and Key Management	196
6.6	Family Relationships	196
6.7	Existing or Proposed Service Agreements	197
6.8	Employees	199
7.	Approvals and Conditions	203
7.1	Approvals and Conditions	203
7.2	Moratorium on Shares	205
8.	Related Party Transactions and Conflict of Interests	207
8.1	Existing and Proposed RPT and Conflict of Interests.....	207
8.2	Transactions That Are Unusual in Their Nature or Conditions	211
8.3	Outstanding Loans (Including Guarantees of Any Kind) Made By Us or Any of Our Subsidiaries to/ for the Benefit of Related Parties.....	211
8.4	Interests in Similar Businesses	214
8.5	Interests in Other Businesses or Corporations Which Are Customers or Suppliers of Our Group	217
8.6	Contracts or Arrangements in Which Our Directors or Substantial Shareholders are Interested and Significant in Relation to Our Business	217
8.7	Declaration by the Advisers	217
9.	Financial Information	219
9.1	Reporting Accountants' Letter on the Proforma Consolidated Financial Information	219
9.2	Historical Financial Information	236
9.3	Capitalisation and Indebtedness.....	237
9.4	Management's Discussion and Analysis of Financial Condition, Results of Operations and Prospects	238
9.5	Liquidity and Capital Resources	291
9.6	Trend Analysis	308
9.7	Dividend Policy.....	308
9.8	Order Book.....	310
10.	Accountants' Report.....	312
11.	Directors' Report.....	475

TABLE OF CONTENTS (Cont'd)

12.	Valuation Certificates	476
13.	Further Statutory and Other General Information	521
13.1	Share Capital	521
13.2	Articles of Association	521
13.3	Directors and Substantial Shareholders	529
13.4	Limitation of Rights.....	529
13.5	Material Contracts.....	530
13.6	Material Litigation or Arbitration	531
13.7	Repatriation of Capital and Profits	531
13.8	General Information	531
13.9	Consents.....	532
13.10	Documents for Inspection	532
13.11	Responsibility Statements.....	533
14.	Procedures for Application and Acceptance	534
14.1	Opening and Closing of Application.....	534
14.2	Methods of Application.....	534
14.3	Procedures for Application.....	534
14.4	Applications Using Application Forms.....	535
14.5	Applications Using Electronic Share Application	538
14.6	Applications Using Internet Share Application	544
14.7	Application and Acceptance.....	552
14.8	CDS Accounts.....	554
14.9	Notice of Allotment.....	554
14.10	List of Authorised Depository Agents.....	556

[THE REST OF THIS PAGE HAS BEEN INTENTIONALLY LEFT BLANK]

INDICATIVE TIMETABLE

The indicative timing of events leading up to the listing of and quotation for our Company's entire enlarged issued and paid-up share capital on the Main Market of Bursa Securities is set out below:-

<u>Date</u>	<u>Event</u>
30 June 2015	: Issue of Prospectus/ opening date of the IPO
7 July 2015	: Closing date of the IPO
9 July 2015	: Tentative date for the balloting of applications
20 July 2015	: Tentative date for the allotment of the IPO shares
27 July 2015	: Tentative date for the listing date

THIS TIMETABLE IS TENTATIVE AND IS SUBJECT TO CHANGES WHICH MAY BE NECESSARY TO FACILITATE IMPLEMENTATION PROCEDURES.

THE APPLICATION PERIOD WILL REMAIN OPEN UNTIL 5.00 P.M. ON 7 JULY 2015 OR FOR SUCH FURTHER PERIOD OR PERIODS AS OUR DIRECTORS, PROMOTERS AND THE OFFEROR TOGETHER WITH THE UNDERWRITER IN THEIR ABSOLUTE DISCRETION MAY MUTUALLY DECIDE. WE WILL NOT ACCEPT LATE APPLICATIONS.

IN THE EVENT THAT THE CLOSING DATE OF THE IPO IS EXTENDED, THE DATES FOR THE BALLOTING, ALLOTMENT AND ALLOCATION OF THE IPO SHARES AND THE LISTING OF OUR COMPANY WILL BE EXTENDED ACCORDINGLY. ANY EXTENSION OF THE ABOVEMENTIONED DATES WILL BE ANNOUNCED BY WAY OF ADVERTISEMENT IN WIDELY CIRCULATED DAILY BAHASA MALAYSIA AND ENGLISH NEWSPAPERS IN MALAYSIA.

[THE REST OF THIS PAGE HAS BEEN INTENTIONALLY LEFT BLANK]

DEFINITIONS

In this Prospectus, unless where the context requires otherwise, the following words and abbreviations shall have the following meanings:-

Acquisition of 60% MM2 Building System	:	The acquisition by our Company of 60.0% of the issued and paid-up share capital of MM2 Building System from Ikhmas Jaya comprising 240,600 ordinary shares of RM1.00 each for a cash consideration of RM260,000. Further details of the Acquisition of 60% MM2 Building System are set out in Section 4.2.2(c) of this Prospectus
Acquisition of Ikhmas Equipment	:	The acquisition by Ikhmas Jaya of 100.0% of the issued and paid-up share capital of Ikhmas Equipment from Rekavista comprising 2 ordinary shares of RM1.00 each for a cash consideration of RM1,480,000. Further details of the Acquisition of Ikhmas Equipment are set out in Section 4.2.2(b) of this Prospectus
Acquisition of Ikhmas Jaya	:	The acquisition by our Company of 100.0% of the issued and paid-up share capital of Ikhmas Jaya comprising 30,000,000 ordinary shares of RM1.00 each for a purchase consideration of RM98,499,900 satisfied entirely via the issuance of 393,999,600 Shares credited as fully paid-up at an issue price of RM0.25 per Share. Further details of the Acquisition of Ikhmas Jaya are set out in Section 4.2.2(a) of this Prospectus
Acquisition of MM2 Builders	:	The acquisition by MM2 Building System of 100.0% of the issued and paid-up share capital of MM2 Builders from Rekavista comprising 100,000 ordinary shares of RM1.00 each for a cash consideration of RM2. Further details of the Acquisition of MM2 Builders are set out in Section 4.2.2(d) of this Prospectus
Acquisitions	:	Collectively, the Acquisition of Ikhmas Jaya, Acquisition of Ikhmas Equipment, Acquisition of 60% MM2 Building System and Acquisition of MM2 Builders
Act	:	The Companies Act, 1965
ADA(s)	:	Authorised Depository Agent(s)
ADA Code	:	ADA (Broker) Code
AmBank	:	AmBank (M) Berhad (8515-D)
AmlInvestment Bank	:	AmlInvestment Bank Berhad (23742-V)
Application Form(s)	:	The official printed application form(s) for the application for the IPO Shares
Application(s)	:	The application(s) for the IPO Shares by way of Application Form, Electronic Share Application and/or Internet Share Application
ATM	:	Automated Teller Machine
Aura Perdana	:	Aura Perdana (Malaysia) Sdn Bhd (303268-K)
Authorised Institution(s)	Financial :	The authorised financial institution(s) participating in the Internet Share Application with respect to payments for the IPO Shares

DEFINITIONS (Cont'd)

BLR	:	Base lending rate
BNM	:	Bank Negara Malaysia
Board	:	The Board of Directors of our Company
Bursa Depository	:	Bursa Malaysia Depository Sdn Bhd (165570-W)
Bursa Securities	:	Bursa Malaysia Securities Berhad (635998-W)
CAGR	:	Compounded annual growth rate
CCM	:	Companies Commission of Malaysia
CDS	:	Central Depository System
Central Depositories Act	:	The Securities Industry (Central Depositories) Act, 1991
CF	:	Certificate of Fitness for Occupation
CIDB	:	The Construction Industry Development Board of Malaysia
CMSA	:	The Capital Markets and Services Act, 2007
CPC	:	Certificate of Practical Completion
Deposited Security	:	A security in the Company standing to the credit of a Securities Account of a Depositor subject to the provision of the Central Depositories Act and the Rules
Depositor	:	A holder of a Securities Account
EBITDA	:	Earnings before interest, taxation, depreciation and amortisation
Electronic Prospectus	:	A copy of this Prospectus that is issued, circulated or disseminated via the internet and/or an electronic storage medium, including but not limited to CD-ROMs
Electronic Application(s) or ESA	Share :	The application(s) for the IPO Shares through a Participating Financial Institutions' ATM
EPS	:	Earnings per Share
FYE	:	Financial year(s) ended or, as the case may be, ending 31 December
GP	:	Gross profit
IJ Geotechnic	:	IJ Geotechnic Sdn Bhd (658318-P)
IJ Holdings	:	Ikhmas Jaya Holdings Sdn Bhd (1072850-X)
Ikhmas Berhad Company	or the :	Ikhmas Jaya Group Berhad (1072872-D)
Ikhmas Berhad Share(s) Share(s)	or :	Ordinary share(s) of RM0.25 each in our Company

DEFINITIONS (Cont'd)

Ikhmas Equipment	:	Ikhmas Equipment Sdn Bhd (<i>formerly known as RV Equipment Sdn Bhd</i>) (495760-W)
Ikhmas Group or the Group	:	Ikhmas Berhad and its subsidiaries, collectively
Ikhmas Jaya	:	Ikhmas Jaya Sdn Bhd (254017-H)
Independent Market Researcher or Vital Factor	:	Vital Factor Consulting Sdn Bhd (266797-T)
Independent Registered Valuers or Rahim & Co	:	Messrs Rahim & Co (Sel) Sdn Bhd (123157-K)
Internet Participating Financial Institution(s)	:	Participating financial institution(s) in the Internet Share Application
Internet Share Application(s)	:	The application(s) for the IPO Shares through an Internet Participating Financial Institution
IPO	:	Initial public offering comprising the Public Issue and the Offer for Sale, collectively
IPO Price	:	RM0.57 per IPO Share, being the price payable by investors under the Public Issue/ Offer for Sale
IPO Share(s)	:	The Public Issue Share(s) and Offer Share(s), collectively
ISO	:	International Organisation for Standardisation
Issuing House or MIH	:	Malaysian Issuing House Sdn Bhd (258345-X)
JV	:	Joint venture
km	:	Kilometre(s)
Listing	:	Admission to the Official List and the listing of and quotation for our entire enlarged issued and paid up share capital of RM130,000,000 comprising 520,000,000 Shares on the Main Market of Bursa Securities
Listing Requirements	:	Bursa Securities Main Market Listing Requirements
Listing Scheme	:	The Subdivision, Acquisitions, Transfer, Public Issue, Offer for Sale and Listing, collectively
LPD	:	4 June 2015, being the latest practicable date prior to the registration of this Prospectus
M&A	:	Memorandum and Articles of Association
M&E	:	Mechanical and electrical services

DEFINITIONS (Cont'd)

m²	:	Meter square
mm	:	Millimetre
MAH	:	Malaysia Airports Holdings Berhad (487092-W)
Malaysian Public or Public	:	Citizens of Malaysia and companies, societies, co-operatives and institutions incorporated or organised under the laws of Malaysia
Market Day(s)	:	Any day between Mondays and Fridays (both days inclusive) which is not a public holiday and a day on which Bursa Securities is open for trading of securities
MIA	:	Malaysian Institute of Accountants
MITI	:	Ministry of International Trade and Industry
MM2 Builders	:	MM2 Builders Sdn Bhd (<i>formerly known as Reka Concrete Products Sdn Bhd</i>) (451935-X)
MM2 Building System	:	MM2 Building System Sdn Bhd (1007002-U)
NA	:	Net assets
NBV	:	Net book value
NTA	:	Net tangible assets
Offer for Sale or Offer	:	The invitation by the Offeror to selected investors to purchase the Offer Shares at the IPO Price, payable in full upon application, subject to the terms and conditions of this Prospectus
Offer Share(s)	:	The 56,000,000 Share(s), which are subject of the Offer for Sale
Offeror	:	IJ Holdings
Official List	:	The official list of the Main Market of Bursa Securities
Participating Institution(s)	Financial :	The participating financial institution(s) for the Electronic Share Application as listed in Section 14.5 of this Prospectus
PAT	:	Profit after taxation
PBT	:	Profit before taxation
PE Multiple	:	Price earnings multiple
Pink Form Shares	:	The 26,000,000 Public Issue Shares, representing 5.0% of the enlarged issued and paid-up share capital of our Company at the IPO Price to be issued to our eligible Directors, employees and business associates (which include the suppliers, sales agents, customer and others) of our Group
Placement Agent	:	AmInvestment Bank
Prescribed Security	:	Shares of a company that are prescribed by Bursa Securities to be deposited in the CDS subject to the provision of the Central Depositories Act and the Rules

DEFINITIONS (Cont'd)

Principal Adviser	:	AmlInvestment Bank
Private Placement	:	The 74,000,000 Public Issue Shares and 56,000,000 Offer Shares at the IPO Price to be allocated in the following manner:- (a) 52,000,000 Offer Shares made available for application by way of private placement to Bumiputera investors approved by the MITI; and (b) Private placement of 74,000,000 Public Issue Shares and 4,000,000 Offer Shares made available for application by way of private placement to selected investors
Promoter(s)	:	IJ Holdings, Dato' Ang Cheng Siong, Aura Perdana, Dato' Ir Dr Khoo Ping Sen, Siew Mun Lout and Ang Wei Zhen collectively
Prospectus	:	This Prospectus dated 30 June 2015 issued by our Company in respect of our IPO
Public Issue	:	The invitation by our Company to the public to subscribe for the Public Issue Shares at the IPO Price, payable in full upon application, subject to the terms and conditions of this Prospectus
Public Issue Share(s)	:	The 126,000,000 new Shares to be issued pursuant to the Public Issue
R&D	:	Research and development
Record of Depositors	:	A record provided by Bursa Depository to our Company under Chapter 24.0 of the Rules
Rekavista	:	Rekavista Sdn Bhd (390493-U)
Rekavista Sarawak	:	Rekavista (Sarawak) Sdn Bhd (517944-P)
Reporting Accountants KPMG	or :	Messrs KPMG (AF 0758)
RM and sen	:	Ringgit Malaysia and sen, respectively
RPT(s)	:	Related party transaction(s)
Rules	:	The Rules of Bursa Depository
SAC	:	Shariah Advisory Council of the SC
SC	:	Securities Commission Malaysia
SC Guidelines	:	The Equity Guidelines issued by the SC
Securities Account	:	An account established by Bursa Depository for a Depositor for the recording of deposit of securities and for dealing in such securities by the Depositor
SME(s)	:	Small and medium enterprise(s)

DEFINITIONS (Cont'd)

Solicitors Hishammuddin	or	Lee :	Messrs Lee Hishammuddin Allen & Gledhill
SPKK		:	Sijil Perolehan Kerja Kerajaan, Malaysia (Certificate of Malaysian Government works procurement)
sqf		:	Square foot/ feet
Subdivision		:	The subdivision of 100 ordinary shares of RM1.00 each into 400 new Shares on the basis of four (4) new Shares for every one (1) existing ordinary share of RM1.00 held
Transfer		:	The transfer of 394,000,000 Shares in Ikhmas Berhad by Dato' Ang Cheng Siong, Aura Perdana, Dato' Ir Dr Khoo Ping Sen, Siew Mun Lout, Yap Yoon Fatt, Yap Beng Teck and Woo Chee Meng to IJ Holdings after the Subdivision and Acquisitions as set out in Section 4.2.3 of this Prospectus
Underwriter		:	AmInvestment Bank
Underwriting Agreement		:	The underwriting agreement dated 8 June 2015 entered into between Ikhmas Berhad and the Underwriter
Vendors		:	Dato' Ang Cheng Siong, Aura Perdana, Dato' Ir Dr Khoo Ping Sen, Siew Mun Lout, Yap Yoon Fatt, Yap Beng Teck and Woo Chee Meng, collectively

[THE REST OF THIS PAGE IS INTENTIONALLY LEFT BLANK]

GLOSSARY OF TECHNICAL TERMS

- Basement** : One or more floors of a building which is partly or entirely below ground level
- Bore piling** : The activity of constructing bored piles
- Bored pile** : Bored piles are formed by boring or excavating a hole into the soil to the required depth. A reinforcement cage made of steel bars is then lowered into the hole and wet concrete is poured in and left to set. A bored pile is generally considered to be a type of replacement pile
- Contiguous bored pile wall** : A type of retaining wall which is constructed using closely spaced bored piles
- CSM** : Cutter soil mix (CSM) refers to a technology used for the construction of retaining walls where cement slurry is mixed with existing soil in situ and allowed to harden. The process utilises two sets of cutting wheels that cut the surrounding soil while simultaneously blending injected cement slurry with the existing soil. This results in the formation of hardened rectangular panels once the cement hardens
- CSM wall** : A type of retaining wall that is similar to a diaphragm wall, except that it is created using CSM technology
- Diaphragm wall** : A type of retaining wall which is constructed by excavating a series of rectangular panels to form a continuous wall. The excavated panels are then filled with reinforced concrete to form the wall
- Displacement pile** : A pile that displaces soil during installation. For example, a driven pile displaces soil as it is being driven into the ground
- Earthworks** : Any operations or works in, on or over land which result in substantial modification to the existing ground terrain, land form or slope. These include removing overburden, excavation, formation of new slope or embankment, and cut and fill operations
- Foundation** : A general term to refer to any structure that supports a load or prevents a force from moving in its original direction. In the context of this Prospectus, foundation refers to either piles or retaining walls. Piles are used to support vertical loads and prevent the load from descending further. Retaining walls are used to prevent the lateral load or force from moving further

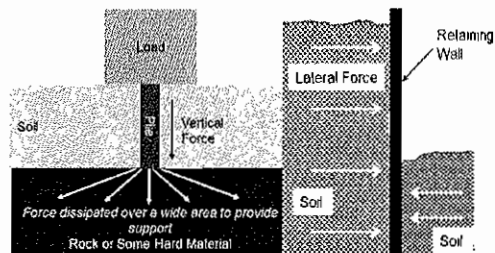

GLOSSARY OF TECHNICAL TERMS (Cont'd)

Pile : Long and slender columns placed below ground to function as foundation to support above ground buildings and other structures. Piles commonly sit above rock formation or some other hard layer of natural or man-made material. The pile's function is to support the above ground structure by transferring its load down to the rock formation or hard layer of material.

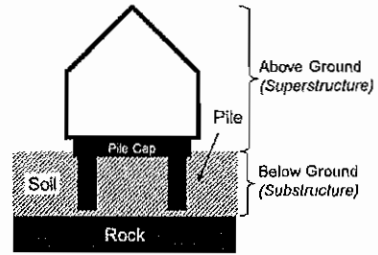

Piles are made of materials such as wood, steel, reinforced concrete, pre-stressed concrete and composites (combination of different materials in the same pile). Most of the piles used today are made of concrete, especially for large structures and high-rise buildings

Prefabricated building system : A system comprising components of a building which are fabricated on-site or off-site, and then installed on-site to complete the building

Replacement pile : Piles that are installed by first removing the soil by methods such as excavation or drilling. The removed soil is then replaced with concrete or other materials to form the pile. It is also known as non-displacement piles

Retaining wall : A type of foundation structure used to retain soil, rock or other materials in a vertical condition. They provide a lateral support to vertical slopes of soil that would otherwise collapse

Secant pile wall : A type of retaining wall which is constructed using intersected bored piles where primary piles (which are usually reinforced) are installed first. Once the primary piles gain sufficient strength, secondary piles are constructed in between the primary piles

Stratum : In geology, stratum refers to a layer of sedimentary rock having approximately the same composition throughout

Substructure : The substructure refers to the bottom part of a contiguous structure that is below a baseline. For buildings, the baseline is the ground level or the basement, and the substructure comprises the foundation works including piling, retention walls and basements.

For bridges, the substructure includes everything below the span such as abutments, piers, piles and other support structures

Superstructure : The superstructure refers to the top part of a contiguous structure that is above a baseline. For buildings, the baseline is the ground level or basement, and the superstructure is the part of the building that is above the ground level or basement.

For bridges, the superstructure includes the span that carries the load and everything on and above the span

PRESENTATION OF INFORMATION

Words referring to the singular shall, where applicable, include the plural and *vice versa*, and words referring to the masculine gender shall, where applicable, include the feminine and neuter genders and *vice versa*. References to persons shall include a company or a corporation.

Any enactment referred to in this Prospectus is a reference to that enactment for the time being amended or re-enacted.

All references to "Ikhmas Berhad" or "the Company" or "our Company" in this Prospectus are to Ikhmas Jaya Group Berhad, references to "Ikhmas Group" or "the Group" or "our Group" are to our Company and our subsidiaries, and references to "we" or "us" or "our" or "ourselves" are to our Company, and where the context requires, our Company and our subsidiaries.

Any reference in this Prospectus, the Application Form(s), Electronic Share Application or Internet Share Application to any legislation, statute or statutory provision is a reference to that legislation, statute or statutory provision for the time being as amended or re-enacted, and to any repealed legislation, statute or statutory provision which it re-enacts (with or without modification). Any word defined in the Act, CMSA, Listing Requirements or any statutory modification thereof and used in this Prospectus and the Application Form(s) shall, where applicable, have the meaning ascribed to it under the Act, CMSA, Listing Requirements or any statutory modification thereof (as the case may be).

Any reference to a time of day in this Prospectus, the Application Form(s), Electronic Share Applications or Internet Share Applications shall be a reference to Malaysia time unless otherwise stated.

The term "entity" includes a corporation, an unincorporated association, a partnership and the government of any state, but does not include a trust.

The word "approximately" used in this Prospectus is to indicate that a number is not an exact one, but that number is usually rounded off to the nearest tenth/ hundredth or one/ two decimal places. Any numeric discrepancies in the tables included in this Prospectus between the listed amounts and the totals thereof are due to rounding differences.

The information on our websites, or any website directly or indirectly linked to such websites does not form part of this Prospectus and you should not rely on it.

[THE REST OF THIS PAGE IS INTENTIONALLY LEFT BLANK]

FORWARD LOOKING STATEMENTS

This Prospectus includes forward-looking statements. All statements other than statements of historical facts included in this Prospectus, including, without limitation, those regarding our financial position, business strategies, prospects, plans and objectives of our Group for future operations, are forward-looking statements. Such forward-looking statements involve known and unknown risks, uncertainties and other factors which may cause our actual results, performance or achievements, or industry results, to be materially different from any future results, performance or achievements expressed or implied by such forward-looking statements. Such forward-looking statements are based on numerous assumptions regarding our present and future business strategies, and the environment in which we will operate in the future. Such forward-looking statements reflect our current views with respect to future events and are not a guarantee of future performance. Forward-looking statements can be identified by the use of forward-looking terminology such as the words "may", "will", "would", "could", "believe", "expect", "anticipate", "intend", "estimate", "aim", "plan", "forecast" or similar expressions and include all statements that are not historical facts. Such forward-looking statements include, without limitation, statements relating to:-

- (a) our future overall business development, operations and financial performance;
- (b) estimated, forecasted or projected financial information in relation to the future development and financial performance of our business;
- (c) potential growth opportunities including advancements in products, services and developments in technology;
- (d) financing plans;
- (e) business strategies, trends and future plans;
- (f) competitive position and the effects of competition;
- (g) our future earnings, cash flow and liquidity;
- (h) the general industry environment, including the demand for our products and services in Malaysia; and
- (i) the regulatory environment and the effects of future regulation.

Actual results may differ materially from information contained in such forward-looking statements as a result of a number of factors, including, without limitation:-

- (a) the general economic and business conditions, social, political and economic developments, demand and supply for our products and services, and investment environment in Malaysia and globally;
- (b) the competitive environment in our industry;
- (c) fixed and contingent obligations and commitments;
- (d) delay, cost overruns or problems with the execution of our expansion plans;
- (e) continued availability of capital and financing;
- (f) interest rates, tax rates and foreign exchange rates;
- (g) significant capital expenditure requirements;
- (h) future regulatory changes affecting us or the construction industry in Malaysia;

FORWARD LOOKING STATEMENTS (Cont'd)

- (i) liability for remedial actions under environmental and/or health and safety regulations;
- (j) the cost and availability of adequate insurance coverage;
- (k) changes in technology especially in prefabricated building system technology; and
- (l) other factors beyond our control.

Additional factors that could cause actual results, performance or achievements to differ materially include, but are not limited to, those discussed elsewhere in Section 3 of this Prospectus on "Risk Factors" and Section 9.4 of this Prospectus on "Management's Discussion and Analysis of Financial Condition, Results of Operations and Prospects". Our Company cannot give any assurance that the forward-looking statements made in this Prospectus will be realised. Such forward-looking statements are made only as at the date of this Prospectus. Our Company expressly disclaims any obligation or undertaking to release publicly any updates or revisions to any forward-looking statement contained in this Prospectus to reflect any change in our expectations with regard thereto or any change in events, conditions or circumstances on which any such statement is based.

[THE REST OF THIS PAGE IS INTENTIONALLY LEFT BLANK]

CORPORATE DIRECTORY**BOARD OF DIRECTORS**

Name/ Designation	Address	Occupation	Nationality
Dato' Syed Ariff Fadzillah bin Syed Awalluddin/ <i>Independent Non-Executive Chairman</i>	No.4, Jalan P10 A2/2 Presint 10 62250 Putrajaya Wilayah Persekutuan (Putrajaya)	Director	Malaysian
Dato' Ang Cheng Siong/ <i>Group Managing Director</i>	No. 11, Jalan USJ 5/1J UEP Subang Jaya 47610 Petaling Jaya Selangor Darul Ehsan	Director	Malaysian
Siew Mun Lou/ <i>Executive Director</i>	No. 6, Jalan Setia Nusantara U13/22S, Setia Eco Park Seksyen U13 40170 Shah Alam Selangor Darul Ehsan	Director	Malaysian
Dato' Ir Dr Khoo Ping Sen/ <i>Executive Director</i>	32, Jalan Athinahapan 3 Taman Tun Dr Ismail 60000 Kuala Lumpur Wilayah Persekutuan	Director	Malaysian
Ang Wei Zhen/ <i>Executive Director</i>	No. 11, Jalan USJ 5/1J UEP Subang Jaya 47610 Petaling Jaya Selangor Darul Ehsan	Director	Malaysian
Dzulkifli David bin Abdullah/ <i>Independent Non-Executive Director</i>	No. 8, Lorong Damai 8 54000 Kuala Lumpur Wilayah Persekutuan	Director	Malaysian
Yuen Choong Lai/ <i>Independent Non-Executive Director</i>	No. 71, Jalan Serindit 10 Kawasan 17, Taman Eng Ann 41150 Klang Selangor Darul Ehsan	Director	Malaysian
Tan Ming-Li/ <i>Independent Non-Executive Director</i>	A3-5B, Astana Damasara 33 Jalan 17/1 46400 Petaling Jaya Selangor Darul Ehsan	Director	Malaysian

[THE REST OF THIS PAGE IS INTENTIONALLY LEFT BLANK]

CORPORATE DIRECTORY (Cont'd)**AUDIT AND RISK MANAGEMENT COMMITTEE**

Name	Designation	Directorship
Yuen Choong Lai	Chairman	Independent Non-Executive Director
Dato' Syed Ariff Fadzillah bin Syed Awalluddin	Member	Independent Non-Executive Chairman
Dzulkifli David bin Abdullah	Member	Independent Non-Executive Director
Tan Ming-Li	Member	Independent Non-Executive Director

NOMINATION AND REMUNERATION COMMITTEE

Name	Designation	Directorship
Dato' Syed Ariff Fadzillah bin Syed Awalluddin	Chairman	Independent Non-Executive Chairman
Dzulkifli David bin Abdullah	Member	Independent Non-Executive Director
Yuen Choong Lai	Member	Independent Non-Executive Director
Tan Ming-Li	Member	Independent Non-Executive Director

COMPANY SECRETARIES : Cynthia Gloria Louis (MAICSA 7008306)
Chew Mei Ling (MAICSA 7019175)

Unit 621, 6th Floor, Block A
Kelana Centre Point
No. 3, Jalan SS7/19, Kelana Jaya
47301 Petaling Jaya
Selangor Darul Ehsan
Telephone No. : (03) 7880 9699
Facsimile No. : (03) 7880 8699

REGISTERED OFFICE : Unit 621, 6th Floor, Block A
Kelana Centre Point
No. 3, Jalan SS7/19, Kelana Jaya
47301 Petaling Jaya
Selangor Darul Ehsan
Telephone No. : (03) 7880 9699
Facsimile No. : (03) 7880 8699

HEAD OFFICE : Nos. 35, 37 & 39, Jalan PJU 1A/41B
Pusat Dagangan NZX
Ara Jaya, PJU1A
47301 Petaling Jaya
Selangor Darul Ehsan
Telephone No. : (03) 7885 0626/ 0612/ 0691
Facsimile No. : (03) 7883 0720
Website : www.ikhmasjaya.com
E-mail : ij@ikhmasjaya.com

CORPORATE DIRECTORY (Cont'd)

- SHARE REGISTRAR** : Symphony Share Registrars Sdn Bhd (378993-D)
Level 6, Symphony House
Pusat Dagangan Dana 1
Jalan PJU 1A/46
47301 Petaling Jaya
Selangor Darul Ehsan
Telephone No. : (03) 7841 8000
Facsimile No. : (03) 7841 8151
- REPORTING ACCOUNTANTS AND AUDITORS** : KPMG (AF 0758)
Level 10, KPMG Tower
8, First Avenue
Bandar Utama
47800 Petaling Jaya
Selangor Darul Ehsan
Telephone No. : (03) 7721 3388
Facsimile No. : (03) 7721 3399
- SOLICITORS FOR THE IPO** : Lee Hishammuddin Allen & Gledhill
Level 16, Menara Tokio Marine Life
189, Jalan Tun Razak
50400 Kuala Lumpur
Telephone No. : (03) 2161 2330
Facsimile No. : (03) 2161 3933/ 1661
- INDEPENDENT REGISTERED VALUERS** : Rahim & Co (Sel) Sdn Bhd (123157-K)
36A, 1st Floor, Jalan Yong Shook Lin
Seksyen 52
46200 Petaling Jaya
Selangor Darul Ehsan
Telephone No. : (03) 7957 9528
Facsimile No. : (03) 7956 5386
- PRINCIPAL BANKERS** : AmBank (M) Berhad (8515-D)
Level 18, Menara Dion
Jalan Sultan Ismail
50250 Kuala Lumpur
Telephone No. : (03) 2026 3939
Facsimile No. : (03) 2026 6855
- CIMB Bank Berhad (13491-P)
L07-02, Wisma BU8
11, Lebuhraya Bandar Utama
47800 Petaling Jaya
Selangor Darul Ehsan
Telephone No. : (03) 7725 1103
Facsimile No. : (03) 7725 2209
- Malayan Banking Berhad (3813-K)
Subang Business Centre
G02, East Wing Wisma Consplant
No. 2, Jalan SS 16/4
47500 Petaling Jaya
Selangor Darul Ehsan
Telephone No. : (03) 5631 2210/ 2203/ 2341/ 2486
Facsimile No. : (03) 5631 2146

CORPORATE DIRECTORY (Cont'd)

- INDEPENDENT MARKET RESEARCHER** : Vital Factor Consulting Sdn Bhd (266797-T)
V Square @ PJ City Centre (VSQ)
Block 6, Level 6, Jalan Utara
46200 Petaling Jaya
Selangor Darul Ehsan
Telephone No. : (03) 7931 3188
Facsimile No. : (03) 7931 2188
- ISSUING HOUSE** : Malaysian Issuing House Sdn Bhd (258345-X)
Level 6, Symphony House
Pusat Dagangan Dana 1
Jalan PJU 1A/46
47301 Petaling Jaya
Selangor Darul Ehsan
Telephone No. : (03) 7841 8000
Facsimile No. : (03) 7841 8150
- PRINCIPAL ADVISER, UNDERWRITER AND PLACEMENT AGENT** : AmInvestment Bank Berhad (23742-V)
22nd Floor, Bangunan AmBank Group
55, Jalan Raja Chulan
50200 Kuala Lumpur
Telephone No. : (03) 2036 2633
Facsimile No. : (03) 2070 8596
- LISTING SOUGHT** : Main Market of Bursa Securities
- SHARIAH STATUS** : Approved by SAC

[THE REST OF THIS PAGE IS INTENTIONALLY LEFT BLANK]

1. INFORMATION SUMMARY

THE INFORMATION SUMMARY IS ONLY A SUMMARY OF THE SALIENT INFORMATION ABOUT OUR GROUP. YOU SHOULD READ AND UNDERSTAND THE WHOLE PROSPECTUS PRIOR TO DECIDING WHETHER OR NOT TO INVEST IN OUR COMPANY'S SHARES. THE INFORMATION SUMMARY SET OUT BELOW IS DERIVED FROM THIS PROSPECTUS AND SHOULD BE READ IN CONJUNCTION WITH THE FULL TEXT OF THIS PROSPECTUS.

1.1 HISTORY AND BUSINESS

We were incorporated in Malaysia under the Act as a public limited company on 5 December 2013 under our present name to serve as an investment holding company and a vehicle for our Listing. Our Group's principal business activities are in engineering and construction, where we are involved in piling and foundation works, bridge construction, building construction and other civil works. Our other business activity is in the manufacturing and installation of prefabricated building system. Over the years, we have established ourselves as a bore piling specialist with a track record of approximately 11 years. Bore piling is a method used in piling and foundation works.

Our Group was founded by Dato' Ang Cheng Siong, our Group Managing Director, Siew Mun Lout, our Executive Director, Dato' Ir Dr Khoo Ping Sen, our Executive Director and Yap Yoon Fatt, our Head of Plant Division. All of our founders have been instrumental in contributing to the strategic direction, growth, development, operation and success of our Group.

The history of our business can be traced back to 1992 with the incorporation of Ikhmas Jaya where our initial activity was in general civil engineering works. In 1994, we successfully secured and commenced our first project, which was the design, construction and commissioning of water pipe laying works.

Thereafter, we incorporated the following companies:-

- (a) Rekavista in 1996, which served as a special purpose vehicle to undertake civil engineering and building construction projects;
- (b) Aliran Ribuan Sdn Bhd (now known as MM2 Builders) in 1997, which is presently involved in the installation of prefabricated building system to support the business operations of MM2 Building System;
- (c) RV Equipment Sdn Bhd (now known as Ikhmas Equipment) in 1999 to provide rental service of construction machinery and equipment for in-house use as well as for external customers;
- (d) Rekavista Sarawak in 2000 to undertake general civil and building construction works in Sarawak; and
- (e) IJ Geotechnic in 2004 to undertake geotechnical works and provide CSM technology, which are complementary to our bore piling and foundation works.

In 2012, we incorporated MM2 Building System and ventured into the manufacturing of prefabricated building system using proprietary "M2 EMMEDUE® Advanced Building System" machinery and equipment from our supplier, EMMEDUE® S.p.A. in Italy.

[THE REST OF THIS PAGE IS INTENTIONALLY LEFT BLANK]

1. INFORMATION SUMMARY (Cont'd)

As at the date of this Prospectus, our Group structure is as follows:-

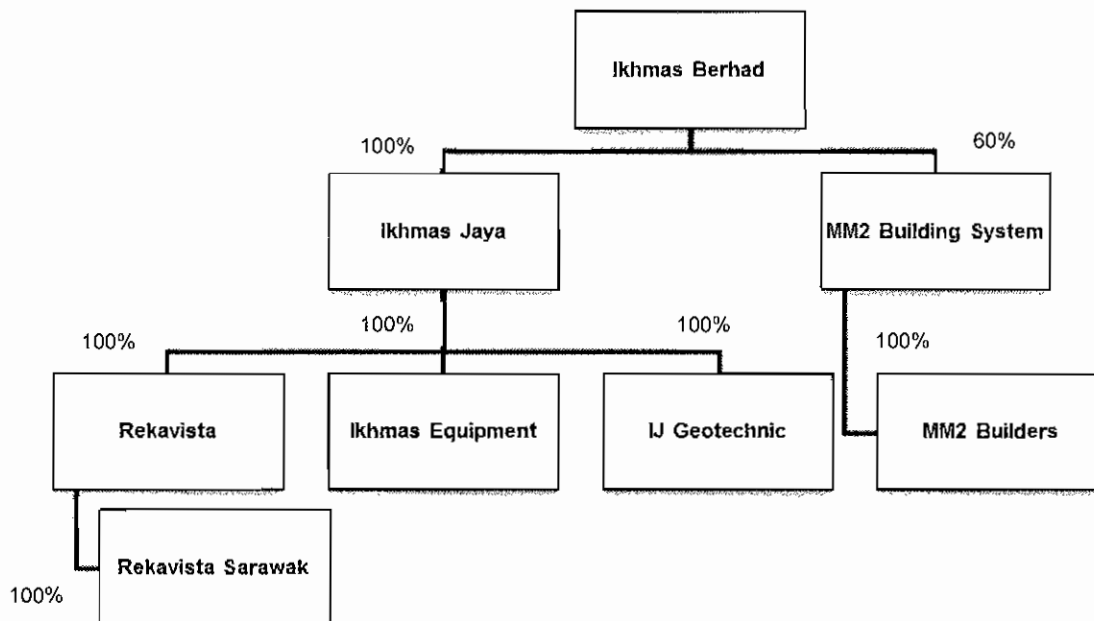

The details of our subsidiaries are as follows:-

Corporation	Date/ Place of Incorporation	Issued and Paid-up Share Capital (RM)	Equity Interest (%)	Principal Activities
Ikhmas Jaya	12.12.1992/ Malaysia	30,000,000	100.0	Piling and foundation works, construction of bridges and buildings, and other civil works
MM2 Building System	21.06.2012/ Malaysia	401,000	60.0	Manufacture of prefabricated building system
<i>Subsidiaries held by Ikhmas Jaya</i>				
Rekavista	14.06.1996/ Malaysia	2,000,000	100.0	General civil and building construction
Ikhmas Equipment	08.10.1999/ Malaysia	2	100.0	Rental of plant, machinery and equipment
IJ Geotechnic	02.07.2004/ Malaysia	2	100.0	Geotechnical works and provision of CSM technology
<i>Subsidiary held by MM2 Building System</i>				
MM2 Builders	05.11.1997/ Malaysia	100,000	100.0	Installation of prefabricated building system
<i>Subsidiary held by Rekavista</i>				
Rekavista Sarawak	23.06.2000/ Malaysia	100	100.0	General civil and building construction

Our Group does not have any associate company.

1. INFORMATION SUMMARY (Cont'd)

Further details of our history, corporate structure, Listing Scheme and achievements are set out in Section 4 of this Prospectus.

1.2 COMPETITIVE ADVANTAGES AND KEY STRENGTHS

Our Directors believe that we have the following competitive advantages and key strengths to ensure our Group's sustainability and growth:-

- (a) Specialists in bore piling;
- (b) In-house design and engineering capabilities;
- (c) In the engineering and construction business for approximately 20 years;
- (d) Own fleet of machinery and equipment;
- (e) Qualified and experienced management and technical team; and
- (f) Quality management systems and safety track record.

Further details on our Group's competitive advantages and key strengths are set out in Section 4.3.3 of this Prospectus.

1.3 PROMOTERS, SUBSTANTIAL SHAREHOLDERS, DIRECTORS AND KEY MANAGEMENT OF OUR GROUP

Our Promoters, substantial shareholders, Directors and key management are as follows:-

Name	Designation
<u>Promoters and Substantial Shareholders</u>	
IJ Holdings	-
Aura Perdana	-
<u>Promoters, Substantial Shareholders and Directors</u>	
Dato' Ang Cheng Siong	Group Managing Director
Dato' Ir Dr Khoo Ping Sen	Executive Director
<u>Promoters and Directors</u>	
Siew Mun Lout	Executive Director
Ang Wei Zhen	Executive Director
<u>Directors</u>	
Dato' Syed Ariff Fadzillah bin Syed Awalluddin	Independent Non-Executive Chairman
Dzulkifli David bin Abdullah	Independent Non-Executive Director
Yuen Choong Lai	Independent Non-Executive Director
Tan Ming-Li	Independent Non-Executive Director
<u>Key Management</u>	
Lum Yuet Ngoh	Chief Financial Officer
Yap Yoon Fatt	Head of Plant Division
Woo Chee Meng	Senior Project Manager
Yap Beng Teck	Senior Contracts Manager

Further details of our Promoters, substantial shareholders, Directors and key management are set out in Section 6 of this Prospectus.

1. INFORMATION SUMMARY (Cont'd)

1.4 PROFORMA CONSOLIDATED STATEMENT OF PROFIT OR LOSS AND OTHER COMPREHENSIVE INCOME

The table below sets out a summary of the proforma consolidated results of our Group for the past four (4) FYE 2011 to FYE 2014 on the assumption that our Group had been in existence throughout the financial years under review. Our proforma consolidated results are prepared for illustrative purposes only and should be read in conjunction with the accompanying notes and assumptions included in the proforma consolidated financial information set out in Section 9 of this Prospectus.

	Proforma			
	FYE 2011	FYE 2012	FYE 2013	FYE 2014
	RM'000	RM'000	RM'000	RM'000
Revenue	145,403	202,868	205,335	293,505
Cost of sales	(118,051)	(165,234)	(151,760)	(235,605)
GP	27,352	37,634	^(a) 53,575	57,900
Other income	1,487	1,458	216	259
Administrative expenses	(6,863)	(7,073)	(6,615)	(8,980)
Other operating expenses	(9,525)	(12,755)	(15,145)	(15,753)
Result from operating activities	12,451	19,264	32,031	33,426
Finance income	249	333	532	686
Finance costs	(1,250)	(2,262)	(3,535)	(5,277)
Fair valuation gain arising from distribution of non-cash assets to owners	-	-	-	-
PBT	11,450	17,335	29,028	28,835
Taxation	(3,072)	(3,849)	(7,568)	(7,426)
PAT	8,378	13,486	21,460	21,409
Attributable to:-				
- Owners of our Company	8,378	13,335	21,435	21,545
- Non-controlling interest	-	151	25	(136)
	8,378	13,486	21,460	21,409
No. of Shares in issue ('000) ^(b)	394,000	394,000	394,000	394,000
Gross EPS (sen) ^(c)	2.91	4.40	7.37	7.32
Net EPS (sen) ^(d)	2.13	3.38	5.44	5.47
Fully diluted net EPS (sen) ^(e)	1.61	2.56	4.12	4.14
EBITDA	16,101	23,976	39,306	42,026
Effective tax rate (%)	26.83	22.20	26.07	25.75
GP margin (%)	18.81	18.55	^(a) 26.09	19.73
PBT margin (%)	7.87	8.54	14.14	9.82
PAT margin (%)	5.76	6.65	10.45	7.29

Notes:-

- The proforma consolidated GP for the FYE 2013 has taken into consideration a reversal of provisions amounting to approximately RM7.18 million. Consequently, the proforma consolidated GP and GP margin of our Group for the FYE 2013 would be approximately RM46.40 million and 22.59% respectively without the incorporating the said reversal of provisions as further disclosed in Section 9.4.2.3(c) of this Prospectus.
- Based on the issued and paid-up share capital of 394,000,000 Shares after Subdivision, Acquisitions and Transfer.
- Gross EPS is computed based on PBT divided by the issued and paid-up share capital of 394,000,000 Shares after Subdivision, Acquisitions and Transfer.
- Net EPS is computed based on PAT attributable to owners of our Company divided by the issued and paid-up share capital of 394,000,000 Shares after Subdivision, Acquisitions and Transfer.
- Fully diluted EPS is computed based on PAT attributable to owners of our Company divided by the issued and paid-up share capital of 520,000,000 Shares after the Public Issue.

1. INFORMATION SUMMARY (Cont'd)

1.5 PROFORMA CONSOLIDATED STATEMENT OF FINANCIAL POSITION

The proforma consolidated statement of financial position as at 31 December 2014 set out below have been prepared for illustrative purposes only to show the effects on the audited statement of financial position, had the Listing Scheme and utilisation of proceeds been effected on that date. The summarised proforma consolidated statement of financial position should be read in conjunction with the accompanying notes and assumptions included in the proforma consolidated financial information set out in Section 9 of this Prospectus.

	Audited as at 31.12.2014 (RM'000)	Proforma I After the Subdivision, Acquisitions and Transfer (RM'000)	Proforma II After Proforma I and Public Issue (RM'000)	Proforma III After Proforma II and Utilisation of Proceeds (RM'000)
ASSETS				
Property, plant and equipment	-	79,466	79,466	116,286
Investment properties	-	2,162	2,162	2,162
Other investments	-	226	226	226
Deferred tax assets	-	19	19	19
Total non-current assets	-	81,873	81,873	118,693
Trade and other receivables	4	178,190	178,190	178,190
Inventories	-	245	245	245
Current tax assets	-	82	82	82
Cash and cash equivalents	2	27,060	98,880	45,060
Total current assets	6	205,577	277,397	223,577
TOTAL ASSETS	6	287,450	359,270	342,270
EQUITY				
Share capital	(a)	98,500	130,000	130,000
Share premium	-	-	40,320	36,858
Merger deficit	-	(68,500)	(68,500)	(68,500)
(Accumulated losses)/ retained earnings	(13)	65,946	65,946	64,408
Total equity attributable to equity holders of the Company	(13)	95,946	167,766	162,766
Non-controlling interests	-	199	199	199
Total equity	(13)	96,145	167,965	162,965
LIABILITIES				
Loans and borrowings	-	19,880	19,880	19,880
Deferred tax liabilities	-	5,561	5,561	5,561
Total non-current liabilities	-	25,441	25,441	25,441
Trade and other payables	19	102,480	102,480	102,480
Loans and borrowings	-	57,317	57,317	45,317
Current tax liabilities	-	6,067	6,067	6,067
Total current liabilities	19	165,864	165,864	153,864
TOTAL LIABILITIES	19	191,305	191,305	179,305
TOTAL EQUITY AND LIABILITIES	6	287,450	359,270	342,270
Number of Shares assumed in issue ('000)	(b)	394,000	520,000	520,000
(Net liabilities)/ NA per Share (RM) attributable to equity holders of the Company	(32.5)	0.24	0.32	0.31

Notes:-

(a) Represents RM100.

(b) Represents 400 ordinary shares of RM0.25 each (after taking into account the issuance of 98 ordinary shares of RM1.00 each on 25 April 2014 and Subdivision).

The financial information of our Group is detailed in Section 9 of this Prospectus.

1. INFORMATION SUMMARY (Cont'd)**1.6 PRINCIPAL STATISTICS RELATING TO THE IPO**

The principal statistics relation to our IPO is set out below:-

	No. of Shares	Share Capital (RM)
Authorised share capital	1,000,000,000	250,000,000
Issued and fully paid-up share capital		
• After Subdivision	400	100
• Shares issued pursuant to the Acquisitions	393,999,600	98,499,900
Existing issued and fully paid-up share capital	394,000,000	98,500,000
New Shares to be issued pursuant to the Public Issue	126,000,000	31,500,000
Enlarged issued and paid-up share capital upon Listing	520,000,000	130,000,000
Offer for Sale	56,000,000	14,000,000
IPO Price per Share		RM0.57
Market Capitalisation (based on the IPO Price and enlarged share capital of 520,000,000 Shares upon Listing)		RM296.40 million
Proforma consolidated NA (excluding non-controlling interests) (after the Public Issue and utilisation of proceeds)		RM162.77 million
Proforma consolidated NA per Share (excluding non-controlling interests) (based on the enlarged issued and paid-up share capital of 520,000,000 Shares upon Listing and after utilisation of proceeds)		RM0.31

Further details on the Listing Scheme are set out in Sections 2.3 and 4.2 of this Prospectus.

[THE REST OF THIS PAGE IS INTENTIONALLY LEFT BLANK]

1. INFORMATION SUMMARY (Cont'd)

1.7 UTILISATION OF PROCEEDS

The total gross proceeds arising from the Public Issue of RM71.82 million will be utilised by our Group in the following manner:-

	Description	Timeframe for Utilisation	⁽¹⁾ Amount (RM'000)	% of Total Gross Proceeds (%)
(a)	Purchase of construction equipment	Within 24 months	31,820	44.31
(b)	Purchase of machinery and equipment for manufacturing of prefabricated building system	Within 24 months	5,000	6.96
(c)	Repayment of bank borrowings	Within 6 months	12,000	16.71
(d)	Working capital	Within 6 months	18,000	25.06
(e)	Estimated listing expenses ⁽²⁾	Immediate	5,000	6.96
	Total Public Issue Proceeds		71,820	100.00

Notes:-

- (1) The proceeds will be placed in interest bearing deposits with licensed financial institutions until eventual utilisation.
- (2) If the actual listing expenses are higher than estimated, the deficit will be funded out of the portion allocated for working capital. Conversely, if the actual listing expenses are lower than estimated, the excess will be utilised for working capital purposes.

Further information on the utilisation of proceeds is set out in Section 2.7 of this Prospectus.

1.8 RISK FACTORS

In evaluating an investment in the IPO Shares, you should carefully consider the following risk factors (which are not exhaustive) in addition to other information contained elsewhere in this Prospectus:-

1.8.1 Risks Relating To Our Business and Operations

- (a) Our business is project-based and there are no long-term contracts;
- (b) We may experience cost overruns for our projects;
- (c) We may encounter delays in the completion of our projects;
- (d) Our business may be affected by defects in our work;
- (e) We rely on subcontractors for our projects;
- (f) We are dependent on foreign workers;
- (g) Our insurance coverage may be inadequate;
- (h) We may suffer financial distress resulting from our borrowings and financing instruments;

1. INFORMATION SUMMARY (Cont'd)

- (i) We are subjected to early termination of our contracts;
- (j) We are reliant on our Directors and key management personnel;
- (k) We face competition from other piling contractors; and
- (l) Our operations may be affected by the risk of relocations.

1.8.2 Risk Relating to the Industry in Which Our Group Operates

- (a) Fluctuation in prices of major building and construction materials;
- (b) Property overhang;
- (c) Implementation of goods and services tax; and
- (d) Political, economic and regulatory uncertainties.

1.8.3 Risks Relating to the IPO

- (a) No prior market for our Shares;
- (b) Capital market risks/ Share price volatility;
- (c) Control by our Promoters;
- (d) Payment of dividends;
- (e) Potential delay or failure of our Listing;
- (f) Delay between admission and trading of the IPO Shares; and
- (g) Disclosure regarding forward-looking statements.

Further details of these risk factors are set out in Section 3 of this Prospectus.

1.9 AUDIT QUALIFICATIONS

The auditors' reports of all the audited financial statements for the relevant financial years/ periods under review were not subject to any qualification, modification or disclaimer of opinion other than the auditors' report on the financial statements of MM2 Builders for FYE 2012 which contained an emphasis on MM2 Builders' dependency on the financial support from the shareholders/ ultimate holding company to enable MM2 Builders to fulfil its obligations as and when they fall due. The shareholders/ ultimate holding company had indicated their willingness to provide continuous financial support to the company.

1.10 SHARIAH STATUS

We have voluntarily submitted an application to the SC for a Shariah compliance review to be carried out by the SAC as part of the process of determining our Shariah status at IPO.

The SAC has classified our securities as Shariah-compliant based on the audited financial statements for the FYE 2014 and the Shariah criteria adopted by the SAC.

2. PARTICULARS OF THE IPO

This Prospectus is dated 30 June 2015. The IPO is subject to the terms and conditions of this Prospectus.

A copy of this Prospectus has been registered with the SC and lodged with the Registrar of Companies who takes no responsibility for its contents.

The approval of the SC for the IPO (details of which are set out in Section 7.1.1 of this Prospectus) shall not be taken to indicate that the SC recommends the IPO. You should rely on your own evaluation to assess the merits and risks of the IPO.

Bursa Securities has approved our admission to the Official List and the listing of and quotation for our entire enlarged issued and paid-up share capital of RM130,000,000 comprising 520,000,000 Shares on the Main Market of Bursa Securities, vide its letter dated 26 June 2015. Listing of and quotation for our Shares will commence after, amongst others, receipt of confirmation from Bursa Depository of the receipt of allotment and allocation information for the crediting of the IPO Shares and receipt of an undertaking that all notices of allotment will be issued and despatched to all successful applicants prior to the date of listing of and quotation for the Shares, failing which any allotment and allocation made on an Application to subscribe for and/or purchase of our Shares pursuant to this Prospectus is required under Malaysian law to be void.

Pursuant to Section 14(1) of the Central Depositories Act, Bursa Securities has prescribed our Shares as a Prescribed Security. In consequence thereof, our Shares issued/ offered through this Prospectus will be deposited directly with Bursa Depository and any dealings in these Shares will be carried out in accordance with the aforesaid Act and the Rules. We will not issue any share certificates to successful applicants.

Person submitting Application by way of Application Form or by way of Electronic Share Application or Internet Share Application must have a CDS account. If you do not have a CDS account, you may open one (1) by contacting any of the ADAs listed in Section 14.10 of this Prospectus. In the case of an Application by way of Application Form, an applicant should state his/her CDS account number in the space provided in the Application Form. In the case of an Application by way of Electronic Share Application or Internet Share Application, only an applicant who is an individual and has a CDS account can make an Electronic Share Application or Internet Share Application. A corporation or institution cannot apply for the IPO Shares by way of Electronic Share Application or Internet Share Application.

Pursuant to the Listing Requirements, our Company must have at least 25.0% of the total number of Shares for which listing is sought in the hands of a minimum of 1,000 public shareholders holding not less than 100 Shares each at the point of our Listing. In the event that the above requirement is not met, we may not be allowed to proceed with our Listing. In the event thereof, monies paid in respect of any Application accepted for the IPO will be returned without interest within fourteen (14) days. If any such monies are not repaid within the said period, the provision of sub-section 243(2) of the CMSA shall apply accordingly.

You should rely on the information obtained in this Prospectus or any applicable supplement. No person is authorised to give any information or to make any representation not contained herein in connection with the IPO and if given or made, such information or representation must not be relied upon as having been authorised by our Company. Neither the delivery of this Prospectus nor any IPO made in connection with this Prospectus shall, under any circumstances, constitute a representation or create any implication that there has been no change in the affairs of our Company since the date hereof. Nonetheless, should our Company become aware of any subsequent material change or development affecting a matter disclosed in this Prospectus arising from the date of issue of this Prospectus up to the date of Listing, our Company shall further issue a supplemental or replacement prospectus, as the case may be, in accordance with the provisions of Section 238 of the CMSA.

2. PARTICULARS OF THE IPO (Cont'd)

The distribution of this Prospectus and the making of the IPO in certain other jurisdictions outside Malaysia may be restricted by law. The distribution of this Prospectus and the sale of any part of the IPO Shares are subject to Malaysian laws and our Company together with the Principal Adviser, Underwriter and Placement Agent, take no responsibility for the distribution of this Prospectus and the offer of any part of the IPO Shares outside Malaysia, which may be restricted by law in certain other jurisdictions. Persons who may come into possession of this Prospectus are required to inform themselves of and to observe such restrictions. This Prospectus does not constitute and may not be used for the purpose of an invitation to subscribe for or an offer to sell the IPO Shares in any jurisdiction in which such invitation or offer is not authorised or lawful or to any person to whom it is unlawful to make such invitation or offer.

The SC and Bursa Securities assume no responsibility for the correctness of any statements made or opinions or report expressed in this Prospectus. Admission to the Official List is not to be taken as an indication of our merit or the merit of our Shares.

IF YOU ARE IN DOUBT CONCERNING THIS PROSPECTUS, YOU SHOULD CONSULT YOUR STOCKBROKER, BANK MANAGER, SOLICITOR, ACCOUNTANT OR OTHER PROFESSIONAL ADVISERS.

2.1 PURPOSES OF THE IPO

The purposes of the IPO are as follows:-

- (a) To enable our Group to gain recognition and enhance our profile through listing status and further augment our corporate reputation;
- (b) To further enhance the financial position of our Group and to enable us to gain access to the capital markets to raise funds for our future expansion, diversification and the overall continued growth of our Group;
- (c) To further enhance our Group's visibility and presence in the Piling, Foundation and Construction Industry in Malaysia; and
- (d) To provide an opportunity for our eligible Directors, employees and business associates of our Group as well as the Malaysian Public to participate in the equity and continuing growth of our Group.

[THE REST OF THIS PAGE IS INTENTIONALLY LEFT BLANK]

2. PARTICULARS OF THE IPO (Cont'd)

2.2 SHARE CAPITAL

As at the LPD, the authorised share capital of our Company is RM250,000,000 divided into 1,000,000,000 Shares and the issued and fully paid-up share capital for our Company is RM98,500,000 comprising 394,000,000 Shares.

Upon the allotment and issuance of the Public Issue Shares pursuant to our IPO, our enlarged issued and paid-up capital of our Company will be RM130,000,000 comprising 520,000,000 Shares as follows:-

	No. of Shares	Share Capital (RM)
Authorised share capital	1,000,000,000	250,000,000
Issued and fully paid-up share capital		
• After Subdivision	400	100
• Shares issued pursuant to the Acquisitions	393,999,600	98,499,900
Existing issued and fully paid-up share capital	394,000,000	98,500,000
New Shares to be issued pursuant to the Public Issue	126,000,000	31,500,000
Enlarged issued and paid-up share capital upon Listing	520,000,000	130,000,000
Offer for Sale	56,000,000	14,000,000
IPO Price per Share		RM0.57
Market Capitalisation (based on the IPO Price and enlarged share capital of 520,000,000 Shares upon Listing)		RM296.40 million
Proforma consolidated NA (excluding non-controlling interests) (after the Public Issue and utilisation of proceeds)		RM162.77 million
Proforma consolidated NA per Share (excluding non-controlling interests) (based on the enlarged issued and paid-up share capital of 520,000,000 Shares upon Listing and after utilisation of proceeds)		RM0.31

Further details on the Listing Scheme are set out in Sections 2.3 and 4.2 of this Prospectus.

Our market capitalisation upon Listing, based on the IPO Price and our enlarged issued share capital of 520,000,000 Shares will be RM296,400,000. The IPO Price is payable in full upon Application, subject to the terms and conditions of this Prospectus. The board lot size for our enlarged issued and paid-up share capital upon Listing will be standardised at 100 Shares per board lot.

As at the date of this Prospectus, our Company has only one (1) class of share, being ordinary shares of RM0.25 each, all of which shall rank *pari passu* with one another. The rights and privileges of our Shares are stated in our M&A.

2. PARTICULARS OF THE IPO (Cont'd)

The Shares owned by our Promoters, Directors and substantial shareholders are not entitled to any different voting rights from the IPO Shares. There is no founder, management or deferred shares reserved for issuance for any purpose. The Public Issue Shares shall upon issuance and allotment, rank *pari passu* in all respects with our other existing Shares, including voting rights, liquidation rights and rights to all dividends and distributions that may be declared, made or paid subsequent to the date of allotment thereof.

Subject to any special rights attaching to any Shares which we may issue in the future, the holders of our Shares shall, in proportion to the amount paid-up on the Shares held by them, be entitled to share in the whole of the profits paid out by us as dividends and other distributions, and in respect of surplus in the event of liquidation in accordance with our M&A and the Act.

At any of our general meeting, each shareholder is entitled to vote and may vote in person or by proxy or by attorney or by duly authorised representative (in the case of a member who is a corporation). On a show of hands, every person who is a member or by proxy or by attorney or by duly authorised representative of a member shall have one (1) vote and on a poll, every member present in person or by proxy or by attorney or by duly authorised representative shall have one (1) vote for each Share held. A member shall not be entitled to appoint more than two (2) proxies to attend and vote at the same meeting.

There are no limitations on the right to own securities including limitations on the right of non-resident or foreign shareholders to hold or exercise voting rights on the securities imposed by law or by the constituent documents of our Company.

2.3 DETAILS OF THE IPO

We (for ourselves and on behalf of the Offeror) will undertake the Public Issue and Offer for Sale in conjunction with and as an integral part of our Listing as follows:-

2.3.1 Public Issue

The Public Issue of 126,000,000 new Shares at the IPO Price per Share representing approximately 24.23% of our enlarged issued and paid-up share capital, payable in full on application upon such terms and conditions as set out in this Prospectus and will be allocated and allotted in the following manner:-

2.3.1.1 Malaysian Public

26,000,000 Public Issue Shares representing 5.0% of our enlarged issued and paid-up share capital will be made available for application by the Malaysian Public, of which at least 50.0% will be set aside strictly for Bumiputera individuals, companies, societies, co-operatives and institutions.

2.3.1.2 Our Eligible Directors, Employees and Business Associates of Our Group

26,000,000 Public Issue Shares representing 5.0% of our enlarged issued and paid-up share capital will be reserved for the eligible Directors, employees and business associates (which include the suppliers, sales agents, customers and others) of our Group.

The Pink Form Shares will be allocated to the eligible Directors and employees of our Group based on the following criteria as approved by our Board:-

- (i) At least eighteen (18) years old;
- (ii) Job position; and

2. PARTICULARS OF THE IPO (Cont'd)

(iii) A full time employee whose employment with our Group has been confirmed.

The Pink Form Shares to be allocated to the business associates of our Group will take into consideration their contribution to the success of our Group.

Details of the Pink Form Shares allocation to our eligible Directors, employees and business associates of our Group are as follows:-

	Number of Persons	Pink Form Shares Allocation
Directors	5	4,500,000
Employees and business associates	Up to 399	21,500,000
Total	Up to 404	26,000,000

Directors

Name of Directors	Designation	Pink Form Shares Allocation
Dato' Syed Ariff Fadzillah bin Syed Awalluddin	Independent Non-Executive Chairman	1,000,000
Ang Wei Zhen	Executive Director	1,000,000
Dzulkifli David bin Abdullah	Independent Non-Executive Director	500,000
Yuen Choong Lai	Independent Non-Executive Director	1,500,000
Tan Ming-Li	Independent Non-Executive Director	500,000
Total		4,500,000

Key Management

Name	Designation	Pink Form Shares Allocation
Lum Yuet Ngoh	Chief Financial Officer	200,000
Yap Yoon Fatt	Head of Plant Division	200,000
Woo Chee Meng	Senior Project Manager	200,000
Yap Beng Teck	Senior Contracts Manager	200,000
Total		800,000

The above Pink Form Shares allocation is subject to the eligible Directors, employees and business associates of our Group subscribing to their respective allocations.

2. PARTICULARS OF THE IPO (Cont'd)

2.3.1.3 Private Placement

74,000,000 Public Issue Shares representing approximately 14.23% of our enlarged issued and paid-up share capital will be reserved by way of Private Placement to selected investors (who are deemed public).

The Public Issue will increase the issued and paid-up share capital of Ikhmas Berhad from RM98,500,000 comprising 394,000,000 Shares to RM130,000,000 comprising 520,000,000 Shares.

All the new Shares to be issued pursuant to the Public Issue shall, upon allotment and issuance, and when fully paid, rank *pari passu* in all respect with the existing issued and paid-up Shares, except that the Public Issue Shares will not be entitled to any dividends, rights, allotments or other distributions declared, made or paid prior to the date of allotment and issuance of the Public Issue Shares.

There is no minimum subscription amount to be raised from the Public Issue.

2.3.2 Offer for Sale

Concurrent with the Public Issue, the Offeror will offer for sale 56,000,000 Shares at the IPO Price representing approximately 10.77% of our enlarged issued and paid-up share capital, payable in full on application upon such terms and conditions as set out in this Prospectus and will be allocated and allotted in the manner set out below:-

2.3.2.1 Bumiputera Investors

52,000,000 Offer Shares representing 10.0% of our enlarged issued and paid-up share capital will be reserved by way of Private Placement to selected Bumiputera investors approved by the MITI.

2.3.2.2 Private Placement

4,000,000 Offer Shares representing approximately 0.77% of our enlarged issued and paid-up share capital are reserved by way of Private Placement to selected investors (who are deemed public).

The entire proceeds of RM31.92 million arising from the Offer for Sale will accrue to the Offeror and not to the Company. Expenses relating to the Offer for Sale will be entirely borne by the Offeror. The Offer Shares will not be underwritten as irrevocable undertakings have been obtained from such investors.

Details of the Offeror are set out below:-

Offeror	Address	Relationship with Our Group Within the Past Three Years (3)	Shareholdings before IPO ⁽¹⁾		Offer for Sale			Shareholdings after IPO ⁽²⁾	
			No. of Shares	%	No. of Shares	% Before IPO ⁽¹⁾	% After IPO ⁽²⁾	No. of Shares	%
IJ Holdings	Unit 621, 6 th Floor, Block A, Kelana Centre Point, No.3, Jalan SS7/19, Kelana Jaya, 47301 Petaling Jaya, Selangor Darul Ehsan	Promoter and substantial shareholder	394,000,000	100.00	56,000,000	14.21	10.77	338,000,000	65.00

2. PARTICULARS OF THE IPO (Cont'd)

Notes:-

- (1) Based on our issued and paid-up share capital of 394,000,000 Shares after the Subdivision, Acquisitions and Transfer.
- (2) Based on our enlarged issued and paid-up share capital of 520,000,000 Shares after the IPO.

2.3.3 Underwriting and Allocation of the IPO Shares

In summary, the IPO Shares will be allocated and allotted in the following manner:-

	Public Issue		Offer for Sale		Total	
	No. of Shares ('000)	% of Enlarged Share Capital	No. of Shares ('000)	% of Enlarged Share Capital	No. of Shares ('000)	% of Enlarged Share Capital
Malaysian Public	26,000	5.00	-	-	26,000	5.00
Our eligible Directors, employees and business associates	26,000	5.00	-	-	26,000	5.00
Selected investors (via Private Placement)	74,000	14.23	4,000	0.77	78,000	15.00
Selected Bumiputera investors approved by the MITI (via Private Placement)	-	-	52,000	10.00	52,000	10.00
Total	126,000	24.23	56,000	10.77	182,000	35.00

All the 52,000,000 Public Issue Shares made available for application by the Malaysian Public and our eligible Directors, employees and business associates of our Group under Sections 2.3.1.1 and 2.3.1.2 respectively of this Prospectus have been fully underwritten.

The IPO Shares made available to selected investors by way of Private Placement are not underwritten as irrevocable undertakings have been obtained from such investors.

The Offer Shares which are not taken up by the selected Bumiputera investors approved by the MITI will be made available for application by the Bumiputera public as part of the balloting process. Subsequently, any of the unsubscribed Shares which are not taken up by the Bumiputera public will be made available for application by the Malaysian Public and/or Private Placement to selected investors.

Any unsubscribed Public Issue Shares by the Malaysian Public will be made available for application by way of Private Placement to selected investors. The number of IPO Shares will not increase via any over-allotment or "greenshoe" option.

Any unsubscribed Public Issue Shares allocated to our eligible Directors, employees and/or business associates will be reoffered to our Group's eligible Directors, employees and/or business associates. Any unsubscribed Shares following such a reoffering will be made available for application by the Malaysian Public on a fair and equitable manner and/or selected investors via the Private Placement. Any further unsubscribed Public Issue Shares will be made available for subscription by the Underwriter based on the terms of the Underwriting Agreement.

There is no minimum subscription amount to be raised from the IPO. All the IPO Shares are either fully underwritten by the Underwriter or subscribed by the identified investors, pursuant to their irrevocable undertakings.

2. PARTICULARS OF THE IPO (Cont'd)

2.4 BASIS OF ARRIVING AT THE IPO PRICE

The IPO Price was arrived at after taking into consideration, *inter-alia*, the following factors:-

2.4.1 Our Financial History

We recorded a proforma consolidated PAT attributable to the owners of our Company of approximately RM21.55 million for FYE 2014. Based on our enlarged issued and paid-up share capital upon our Listing of 520,000,000 Shares, our proforma consolidated net EPS is approximately 4.14 sen.

Further details on our financial history are set out in Section 9 of this Prospectus.

2.4.2 Our Operating History

Our Group's principal business activities are in engineering and construction, where we are involved in piling and foundation works, bridge construction, building construction and other civil works. Over the years, we have established ourselves as a bore piling specialist with a track record of approximately 11 years.

Further details on our operating history and the nature of our business are set out in Section 4 of this Prospectus.

2.4.3 Our Proforma Consolidated NA

Our proforma consolidated NA attributable to equity holders of our Company as at 31 December 2014 stood at approximately RM162.77 million or RM0.31 per Share based on our enlarged issued and paid-up share capital of 520,000,000 Shares upon Listing and after taking into consideration the utilisation of proceeds from the Public Issue.

2.4.4 Our Future Plans and Prospects

Our future plans are focused in the expansion of bore piling fleet as well as in the relocation and expansion of our prefabricated building system manufacturing facility. Premised on our aforementioned future plans and strategies as detailed in Sections 4.18.1 and 4.18.2 of this Prospectus as well as the prospects and outlook of the industry as summarised in Section 4.18.5 of this Prospectus, we believe that we will continue to enjoy positive growth and favourable prospects over the next few years.

2.4.5 Our Competitive Advantages and Key Strengths

Our competitive advantages and key strengths include being bore piling specialists, having in-house design and engineering capabilities, our experience in the engineering and construction business for approximately 20 years, our own fleet of machinery and equipment, our qualified and experienced management and technical team as well as our compliance to the quality management systems and our achievement in the safety track record. These competitive advantages and key strengths as set out in Section 4.3.3 of this Prospectus, provide us with the platform to compete against other piling, foundation and construction companies, as well as facilitate business sustenance and future growth.

2.4.6 Our PE Multiple

Based on our enlarged issued and paid-up share capital upon our Listing of 520,000,000 Shares, our proforma consolidated net EPS for the FYE 2014 is approximately 4.14 sen. Our IPO Price translates into a proforma PE Multiple of approximately 13.77 times.

Our Directors and the Offeror are of the opinion that the IPO Price is fair and reasonable after careful consideration of the abovementioned factors.

2. PARTICULARS OF THE IPO (Cont'd)

Prospective investors should note that the market price of our Shares upon listing on Bursa Securities is subject to the vagaries of market forces and other uncertainties which may affect the market price of our Shares. Prospective investors should consider the risk factors set out in Section 3 of this Prospectus, form their own views on the valuation of the IPO Shares before deciding to invest in the IPO Shares.

2.5 MARKET CAPITALISATION UPON LISTING

Based on the IPO Price and our enlarged issued and paid-up share capital of 520,000,000 Shares, our market capitalisation upon Listing will be RM296.40 million.

2.6 DILUTION

Dilution is the amount by which the IPO Price to be paid by the investors for our Shares exceeds our proforma consolidated NA per Share immediately after the implementation of the Listing Scheme. The proforma consolidated NA per Share (excluding non-controlling interests) as at 31 December 2014 based on the issued and paid-up share capital of 394,000,000 Shares before the Public Issue is approximately RM0.24 per Share.

Pursuant to the Public Issue of 126,000,000 new Shares at the IPO Price and after adjusting for the effects of the utilisation of proceeds, the proforma consolidated NA per Share of our Group (excluding non-controlling interests) as at 31 December 2014 will increase to approximately RM0.31 per Share based on the enlarged issued and paid-up share capital of 520,000,000 Shares after the Public Issue and utilisation of proceeds. This represents an immediate increase in adjusted NA of approximately RM0.07 per Share to our existing shareholders and an immediate dilution in NA of approximately RM0.26 per Share to our new investors representing approximately 45.61% dilution. The following table illustrates such dilution on a per Share basis:-

	RM
IPO Price	0.57
Proforma consolidated NA per Share (excluding non-controlling interests) as at 31 December 2014 (after Subdivision, Acquisitions and Transfer)	0.24
Increase in proforma consolidated NA per Share (excluding non-controlling interests) after adjusting for the Public Issue and utilisation of proceeds	0.07
Proforma consolidated NA per Share (excluding non-controlling interests) after the Public Issue and utilisation of proceeds	0.31
Dilution in NA per Share to new investors	0.26
Dilution in NA per Share to new investors as a percentage of the IPO Price	45.61%

[THE REST OF THIS PAGE IS INTENTIONALLY LEFT BLANK]

2. PARTICULARS OF THE IPO (Cont'd)

Save as disclosed in the table below, which summarises the total number of Shares acquired by our Promoters, Directors and substantial shareholders, the total consideration paid by them and the average effective cash cost per Share to them and to the new investors who subscribe for and/or purchase the IPO Shares pursuant to the Public Issue and Offer for Sale, there has been no other equity transaction and/or right to acquire during the past three (3) years prior to the date of this Prospectus:-

	Date	Number of Shares Acquired	Total Consideration (RM)	Average Price Per Share (RM)
IJ Holdings	03.06.2015	^(a) 394,000,000	98,500,000	0.25
Dato' Ang Cheng Siong	05.12.2013	1	1	1.00
	25.04.2014	49	49	1.00
	19.06.2014	1	1	1.00
	03.06.2015	^(b) 120,498,196	30,124,549	0.25
Aura Perdana	03.06.2015	^(b) 110,464,400	27,616,100	0.25
Dato' Ir Dr Khoo Ping Sen	05.12.2013	1	1	1.00
	25.04.2014	48	48	1.00
	03.06.2015	^(b) 93,995,004	23,498,751	0.25
Siew Mun Lout	03.06.2015	^(b) 35,250,000	8,812,500	0.25
New investors				
- Public issue	Not applicable	126,000,000	71,820,000	0.57
- Offer For Sale	Not applicable	56,000,000	31,920,000	0.57

Notes:-

- (a) Pursuant to Transfer.
(b) Pursuant to Acquisition of Ikhmas Jaya.

2.7 UTILISATION OF PROCEEDS

The Public Issue will raise gross proceeds of RM71.82 million which we intend to utilise in the following manner:-

	Description	Timeframe for Utilisation	⁽¹⁾ Amount (RM'000)	% of Total Gross Proceeds (%)
(a)	Purchase of construction equipment	Within 24 months	31,820	44.31
(b)	Purchase of machinery and equipment for manufacturing of prefabricated building system	Within 24 months	5,000	6.96
(c)	Repayment of bank borrowings	Within 6 months	12,000	16.71
(d)	Working capital	Within 6 months	18,000	25.06
(e)	Estimated listing expenses ⁽²⁾	Immediate	5,000	6.96
Total Public Issue Proceeds			71,820	100.00

2. PARTICULARS OF THE IPO (Cont'd)

Notes:-

- (1) The proceeds will be placed in interest bearing deposits with licensed financial institutions until eventual utilisation.
- (2) If the actual listing expenses are higher than estimated, the deficit will be funded out of the portion allocated for working capital. Conversely, if the actual listing expenses are lower than estimated, the excess will be utilised for working capital purposes.

(a) Purchase of Construction Equipment

Our Group shall set aside RM31.82 million of the Public Issue proceeds for the purchase of construction equipment to facilitate the expansion of our bore piling fleet. The availability of additional construction equipment will enable our Group to be less dependent on the rental of such construction equipment from external parties and at the same time, will allow us to be in control of our construction schedules, thus ensuring our timely completion of our projects. The potential savings in rental of the construction equipment from external parties are estimated to be between RM3.78 million and RM7.35 million per year over a five (5)-year period. Having our own construction equipment will increase our planning efficiencies in our construction, which will enable our Group to be more competitive in our pricing in the bidding for contracts.

The abovementioned purchase of additional construction equipment is in line with our Group's strategy in providing the platform to reinforce one of our competitive advantages and key strengths of owning our own fleet of machinery and equipment as disclosed in Section 4.3.3(d) of this Prospectus. For the FYE 2014, our Group paid approximately RM13.22 million for renting construction equipment from external parties.

Further, the expansion of our fleet of bore piling machinery will enable us to capitalise on the anticipated growth in business opportunities in the Piling, Foundation and Construction Industry in Malaysia.

Please refer to Section 4.18.1 of this Prospectus for further details.

(b) Purchase of Machinery and Equipment for Manufacturing of Prefabricated Building System

Our Group has earmarked RM5.0 million of the Public Issue proceeds for the purchase of an additional line of machinery and equipment for our new prefabricated building system manufacturing facility.

The machinery and equipment for the additional manufacturing line of prefabricated building system comprises the following:-

Description of Machinery and Equipment	No. of Unit	Total (RM'000)
Mesh machine	1	2,500
Panel machine	1	2,250
Ancillary equipment*	1	250
Total		5,000

Note:-

- * Including one unit each of wire straightener, air cleaner and compressor.

2. PARTICULARS OF THE IPO (Cont'd)

This is for the anticipated expansion of our prefabricated building system manufacturing and installation business. Our annual production capacity is expected to increase to a total of about 900,000 m² with the expected additional 450,000 m² annual production capacity contribution from our new line of machinery and equipment as compared to our existing annual production capacity of 450,000 m². This will be used for the manufacture of a new range of products which will contribute positively to the future earnings of our Group.

Please refer to Section 4.18.2 of this Prospectus for further details.

(c) Repayment of Bank Borrowings

As at the LPD, our Group's total bank borrowings is approximately RM73.69 million. Our Group shall set aside RM12.0 million of the proceeds to pare down part of our Group's existing bank borrowings which was obtained to finance our working capital requirements as set out in the table below:-

Banks	Type of Facilities	Repayment Amount (RM'000)
AmBank	Overdrafts	5,000
AmBank	Trust receipts	3,643
CIMB Bank Berhad	Overdraft	1,600
Malayan Banking Berhad	Short term loan	890
Other banks	Overdrafts	867
Total		12,000

Based on the prevailing average interest rate incurred by our Group of approximately 8.36% per annum, such repayment is expected to result in an interest savings of approximately RM1.00 million per annum. The repayment will also reduce the gearing of our Group and hence improve our Group's liquidity position in the future. Any unutilised amount will be used towards working capital.

(d) Working Capital

Our requirement for working capital will increase in tandem with our expected expansion and business growth. We expect to utilise RM18.0 million of the Public Issue proceeds to finance our Group's working capital requirements for our Group's day-to-day operations including the working capital requirements for our Group's future projects as set out in the table below:-

Working Capital Requirements	Approximate Allocation	
	Percentage	RM'000
Purchase of raw materials including reinforcing bar, concrete and formwork	50%	9,000
Payment to sub-contractors	25%	4,500
Maintenance costs and purchase of spare parts, diesel and oil lubricant for construction equipment	15%	2,700
Payment of salaries and office expenses	10%	1,800
Total	100%	18,000

2. PARTICULARS OF THE IPO (Cont'd)**(e) Estimated Listing Expenses**

The estimated listing expenses for the Listing are as follows:-

Estimated listing expenses	Amount RM'000
Professional fees ⁽¹⁾	2,000
Fees to authorities	550
Underwriting, placement fees and brokerage fees	2,000
Printing, advertising and other expenses in relation to the Listing	300
Other miscellaneous expenses ⁽²⁾	150
Total	⁽³⁾ 5,000

Notes:-

- (1) Includes fees for the Principal Adviser, Reporting Accountants, Solicitors, Independent Market Researcher and other professional advisers, as well as the Issuing House.
- (2) Other incidental or related expenses in connection with the Listing.
- (3) If the actual listing expenses are higher than budgeted, a portion of the amount allocated for working capital purposes will be utilised to fund the deficit. Conversely, if the actual listing expenses are lower than budgeted, the excess will be utilised for working capital purposes.

Our Company will bear all expenses and fees incidental to the Listing which include underwriting and selling commission, placement fees, brokerage fees, professional fees, fees to authorities, advertising and other fees, the aggregate of which is estimated to be approximately RM5.0 million.

The Offer for Sale is expected to raise proceeds of RM31.92 million. The entire proceeds of the Offer for Sale shall accrue entirely to the Offeror and no part of the proceeds is receivable by our Company. The Offeror shall bear all expenses such as placement, management and miscellaneous fees relating to the Offer Shares estimated to be approximately RM1.0 million.

2.8 FINANCIAL IMPACT FROM UTILISATION OF PROCEEDS

Our utilisation of the proceeds from the IPO is expected to have the following financial impact on our Group:-

(a) Enhancement of Working Capital

We will utilise RM18.0 million of the Public Issue proceeds for our working capital requirements as outlined in Section 2.7(d) of this Prospectus. Consequently, our cash and cash equivalents balance will improve from approximately RM27.06 million to approximately RM45.06 million (based on our Group's proforma cash and cash equivalents as at 31 December 2014 after taking into consideration the Subdivision, Acquisitions, Transfer, Public Issue and utilisation of proceeds as disclosed in Section 1.5 of this Prospectus). This will allow us to be less reliant on external funding to finance our expected growth in business activities.

(b) Interest Savings

We will utilise RM12.0 million of the Public Issue proceeds to pare down part of our Group's existing bank borrowings as outlined in Section 2.7(c) of this Prospectus. As such, based on an assumed average interest rate of 8.23% per annum, we expect to have an interest savings of approximately RM0.99 million per annum.

2. PARTICULARS OF THE IPO (Cont'd)

2.9 UNDERWRITING COMMISSION, PLACEMENT FEE AND BROKERAGE

(a) Brokerage Fee

We will pay the brokerage fee to be incurred on the sale of the 26,000,000 Public Issue Shares under Section 2.3.1.1 of this Prospectus at the rate of 1.0% of the IPO Price in respect of successful applications by the Malaysian Public which bear the stamp of member companies of Bursa Securities, members of the Association of Banks in Malaysia, members of the Malaysian Investment Banking Association and/or the Issuing House.

(b) Placement Fee

We will pay the Placement Agent a placement fee at the rate of 2.0% of the value of the 74,000,000 Public Issue Shares reserved for Private Placement under Section 2.3.1.3 of this Prospectus (being the number of Public Issue Shares reserved for Private Placement multiplied by the IPO Price).

The Offeror will pay the Placement Agent a placement fee at the rate of 2.0% of the value of the 56,000,000 Offer Shares reserved for Private Placement under Section 2.3.2 of this Prospectus (being the number of Offer Shares reserved for Private Placement multiplied by the IPO Price).

(c) Underwriting Commission

We will pay the Underwriter an underwriting commission at the rate of 2.0% of the value of the total underwritten 52,000,000 Public Issue Shares made available for application by the Malaysian Public and our eligible Directors, employees and business associates under Sections 2.3.1.1 and 2.3.1.2 of this Prospectus (being the number of Public Issue Shares made available for application by the Malaysian Public and our eligible Directors, employees and business associates multiplied by the IPO Price).

2.10 SALIENT TERMS OF THE UNDERWRITING AGREEMENT

The salient terms of the Underwriting, including provisions which may allow the Underwriter to withdraw from its obligations under the Underwriting Agreement after the IPO as extracted from the Underwriting Agreement, are set out below.

Unless otherwise stated, all capitalised terms herein shall bear the same meanings as prescribed in the Underwriting Agreement.

“CONDITIONS PRECEDENT

3.1 Conditions Precedent

Unless waived in writing by the Underwriter, the obligations of the Underwriter under this Underwriting Agreement are conditional inter alia upon:

- (a) *The Prospectus being in form and substance satisfactory to the Underwriter;*
- (b) *There shall not have occurred, on or prior to the Closing Date, in the opinion of the Underwriter any material adverse change or any development reasonably likely to involve a prospective material adverse change in the condition (financial or otherwise) of the Group;*

2. PARTICULARS OF THE IPO (Cont'd)

- (a) *The Underwriter being satisfied with inter alia the following:*
- (i) *that there shall not have occurred, on or prior to the Closing Date, any material breach of or failure to perform any of the undertakings contained in Clause 6.1 therein by the Issuer;*
 - (ii) *with the arrangements made by the Issuer in relation to the payment of the expenses referred to in Clause 9.3 therein;*
 - (iii) *that the Public Issue is not prohibited by any statute, order, rule, regulation or directive promulgated or issued by any legislative, executive or regulatory body or authority in Malaysia;*
 - (iv) *that the Proposed IPO and subscription of the Shares in accordance with the provisions therein are not prohibited or impeded by any statute, order, rule, directive or regulation promulgated by any legislative, executive or regulatory body or authority of Malaysia (including Bursa Securities) and any other jurisdiction within which such Shares are offered*
- (b) *The Underwriter shall have received the following documents from the Issuer:*
- (i) *such reports and confirmations dated the Closing Date from the board of directors of the Issuer as the Underwriter may reasonably require to confirm that there has not been any material adverse change or any development reasonably likely to involve a prospective material adverse change in the condition (financial or otherwise) of the Issuer and its subsidiaries from that existing as at the date of this Underwriting Agreement which is material in the context of the Public Issue and the listing and quotation of the Public Issue Shares and/or the Underwritten Shares;*
 - (ii) *a certificate dated the Closing Date signed by a duly authorised officer of the Issuer stating that, to the best of his knowledge and belief, having made all reasonable enquiries, there has been no such change, development or occurrence as is referred to in (i) above; and*
 - (iii) *the duly certified copy of the resolution of the board of directors of the Issuer approving the following:-*
 - (1) *the Proposed IPO;*
 - (2) *the Prospectus;*
 - (3) *this Underwriting Agreement and the transactions contemplated hereunder;*
 - (4) *the issue and offer of the Public Issue Shares; and*
 - (5) *authorising a person or persons to sign this Underwriting Agreement on behalf of the Issuer; and*
- (c) *Nothing has come to the knowledge of the Underwriter, up to the Closing Date, which shall prevent, impede or prohibit the Proposed IPO including but not limited to occurrence of such events which shall invalidate or nullify any approvals, consents from relevant authorities pertaining to the Proposed IPO.*

3.2 Non-Fulfilment of Conditions Precedent

If any of the conditions in Clause 3.1 is not satisfied or waived on or before the Closing Date, the Underwriter shall be entitled to terminate this Underwriting Agreement by notice in writing to the Issuer.

2. PARTICULARS OF THE IPO (Cont'd)

TERMINATING EVENTS

10.1 Terminating Event

The following events shall constitute a Terminating Event:

- (a) *the Issuer is in breach of its obligations or of warranties, representations or undertakings in Clause 6.1, which is not capable of remedy or, if capable of remedy, is not remedied within ten (10) Market Days from the date the Issuer is notified by the Underwriter;*
- (b) *if there is withholding of information by the Issuer which would have or can reasonably be expected to have a material adverse effect on the business, operations or financial condition of the Issuer or its subsidiaries, the success of the Public Issue, or the distribution or sale of the Public Issue Shares;*
- (c) *if a petition is presented or an order is made or a resolution is passed for the winding up of the Issuer or an administrator or receiver and manager is appointed over, or distress, attachment or execution is levied or enforced upon, any part of its assets;*
- (d) *the Issuer or its subsidiaries becomes insolvent or is unable to pay its/their debts or enters into any composition or arrangement with its creditors or ceases/cease or threatens to cease to carry on the whole or any substantial part of its business;*
- (e) *it becomes unlawful for the Underwriter to participate in the subscription of the Public Issue Shares or in the underwriting contemplated in this Underwriting Agreement or the listing of and quotation for the share capital of the Issuer is withdrawn or procured by subject to the conditions which are not acceptable to the Underwriter;*

there shall have occurred, any material change, or any development involving a prospective change, in national or international monetary, financial, economic or political conditions or exchange control or currency exchange rates or any change in law, regulation, directive, policy or ruling in any jurisdiction or any events beyond the reasonable control of the Underwriter, interpretation or application by the court or such relevant authorities which can reasonably be expected to have a material adverse effect the business, operation and/or financial position of the Issuer and its subsidiaries or the success of the Public Issue.

10.2 Consequences of a Terminating Event

Upon the occurrence of a Terminating Event, the Underwriter shall be entitled to terminate this Underwriting Agreement by giving a written notice to the Issuer at any time before the completion of the Proposed IPO and thereafter this Underwriting Agreement shall have no force and effect save for any antecedent breaches subject to the liability of the Issuer for the payment of costs and expenses as provided in this Underwriting Agreement incurred prior to or in connection with such termination and the Underwriting Commission shall remain.

[THE REST OF THIS PAGE IS INTENTIONALLY LEFT BLANK]

3. RISK FACTORS

IN EVALUATING AN INVESTMENT IN THE IPO SHARES, YOU SHOULD CAREFULLY CONSIDER ALL INFORMATION CONTAINED IN THIS PROSPECTUS INCLUDING BUT NOT LIMITED TO THE FOLLOWING GENERAL AND SPECIFIC RISKS.

3.1 RISKS RELATING TO OUR BUSINESS AND OPERATIONS

3.1.1 Our Business Is Project-based and There Are No Long-term Contracts

We are primarily an engineering and construction company where our principal business is in piling and foundation works, and construction of bridges. We are normally awarded contracts on a project-by-project basis. There is no assurance of continuity from one project to the next project. We have to bid competitively for every contract that we secure. There is a risk that we may not be successful in continually winning contracts. Any failure in winning sufficient contracts will affect the profitability, long term sustainability and growth of our business.

In our industry, it is common for jobs to be awarded based on competitive bidding, especially for large projects as well as for public sector jobs. Since the commencement of our business in 1994, we have been operating under a project-based environment. Between FYE 2011 and FYE 2014, our revenue grew by a CAGR of approximately 26.38%. This demonstrates our capability in sustaining as well as growing our business under a project-based business environment. We serve a diverse customer base of private and public sector clients. For FYE 2014, we have a total of 21 customers which contributed to our Group's total revenue. The diversity of customers provide us with opportunities to win contracts, while the number of customers indicate our capability in winning contracts to sustain as well as to grow our business.

However, depressed crude oil prices may have a negative impact on our Group. Gross domestic product ("GDP") contribution of the oil and gas sector was approximately 10% of Malaysia's total GDP in 2013. As such, a prolonged low crude oil price would have a negative impact on the overall economic growth of the Malaysian economy. Amongst others, lower crude oil prices would adversely affect oil revenue received by the Malaysian Government ("Government") as Malaysia is a net exporter of crude oil. In 2013, oil-related revenue contributed an estimated RM63 billion to the Government, comprising approximately RM36 billion in tax income and royalties, and approximately RM27 billion in dividends. This accounted for approximately 30% of the total Government revenue in 2013. Amidst the fall in global crude oil prices, Petrolim Nasional Bhd had announced its intention to cut capital expenditure by up to 20% and operating expenditure by up to 30%. This may cause the Government to cut or postpone development expenditure, which may in turn, delay the implementation of various mega projects for the construction sector that was announced during the Budget 2015. For FYE 2014, the public sector projects accounted for approximately 50.02% of our Group's total revenue. As such, our Group could be negatively impacted by lesser Government projects available for bidding.

As at the LPD, our order book comprised contracts amounting to a total of approximately RM346 million as disclosed in Section 9.8 of this Prospectus. The order book includes public sector as well as private sector projects. As such, it is likely that the revenue of our Group would be sustainable up to mid-2016. Moreover, our Group is confident of replenishing our order book from projects tendered. As at the LPD, our Group's tender book amounted to approximately RM3 billion for public and private sector projects. Based on the past four (4) financial years from the FYE 2011 to the FYE 2014, our average success rate from our tenders was approximately 6%. In addition, for the revised Budget 2015, it was announced that the development expenditure of RM48.5 billion will be maintained. Nevertheless, there is no assurance that projects from our order book may not be delayed or terminated, or we will continue to win sufficient projects to sustain and grow our business, which may have an adverse impact on the financial performance of our Group.

3. RISK FACTORS (Cont'd)

3.1.2 We May Experience Cost Overruns for Our Projects

Most of our order book comprises fixed-price contracts. There is a risk of one or more of the following events occurring, that will result in cost overruns for our projects:-

- (a) underestimation of our costs;
- (b) unanticipated increase in prices of raw materials and other input costs;
- (c) unanticipated operating conditions that increase our operating costs, for example encountering unfavourable soil conditions; and
- (d) delays in completion due to unforeseen circumstances including exceptional adverse weather conditions, breakdown in machinery and equipment, and insufficient human resources.

Any cost overruns will affect our profitability. During FYE 2011 to FYE 2014, we have experienced negative GP margin for a piling foundation works for Tabung Haji office complex in Putrajaya that commenced in the FYE 2011 and completed in the FYE 2013. This was mainly attributed to the soil conditions that required longer drilling time as well as due to an insufficient supply of labour.

We make a conscious effort to avoid cost overruns at all times. Nevertheless, there is no assurance that we will be able to contain cost overruns for all our projects, which may have an adverse impact on the financial performance of our Group.

3.1.3 We May Encounter Delays in the Completion of Our Projects

All of our projects have agreed milestones and specific completion dates. There is a risk that we may encounter delays in completing our projects or meeting agreed milestones. Failure to complete our projects on time or meet agreed milestones may subject us to financial penalties and/or increase our overall costs, claims arising for liquidated damages by our customers, and thus reduce our profitability.

For FYE 2011 to FYE 2014 and up to the LPD, we have experienced delays on project completion as follows:-

- (a) The scheduled completion date for piling and foundation works for Tabung Haji office complex in Putrajaya was September 2012. However, its completion was delayed until February 2013, which was mainly contributed by soil conditions that required longer drilling time, as well as insufficient supply of labour. The delay in completion of this project incurred a liquidated damages cost of RM275,000, where provisions have already been made by us accordingly as at the LPD. We had on 12 August 2014 appealed to the project owner to seek waiver in relation to the liquidated damages and the approval for the appeal is pending as at the LPD;
- (b) The scheduled completion date for piling and foundation works for DA:Men, USJ project was October 2012. However, its completion was delayed until June 2013, which was mainly contributed by soil conditions that required longer time to carry out additional soil stabilisation works. The delay in completion of this project incurred a liquidated damages cost of RM495,000 where provisions have already been made by us accordingly in FYE 2012. As at the LPD, we were in discussion with the project owner to seek waiver in relation to the liquidated damages; and

3. RISK FACTORS (Cont'd)

- (c) The revised completion date for piling and foundation works for stage 1 (Section 2) of Parcel D of the KL Eco City project was April 2014. However, the completion of stage 1 (Section 2) of this project was subsequently delayed, which was mainly contributed by the delay in the handover of the site by the project owner and halt in the construction work for a few months due to the detection of existing sewage and water piping at the site during the construction works, which was not spot out in the original design. Subsequently, we also received variation orders to carry out additional construction works for the relocation of the sewage and water piping as well as additional structures to be constructed on-site. The delay in completion of this project incurred a liquidated damages cost of RM360,000, where provisions have already been made by us accordingly as at the LPD. As at the LPD, we were in discussion with the project owner to seek waiver in relation to the liquidated damages.

Some of the delays were due to extenuating circumstances beyond our control. Nevertheless, we make conscious efforts to minimise potential project delays through amongst others, prudent project scheduling using Microsoft Project and Primavera Project Planning Software to plan and monitor the progresses of projects, as well as leveraging from our experiences in similar past projects. We also have a wide range of machinery and equipment in-house to reduce dependency on external suppliers.

Nevertheless, there is no assurance that we will be able to avoid delays in completing all of our projects or meeting all of our project milestones, which may have an adverse impact on the financial performance of our Group.

3.1.4 Our Business May Be Affected by Defects in Our Work

As an engineering and construction company we are responsible for the work which we perform. Any defects in our works may compromise the safety of the structures.

There is a risk that our works may be defective and directly or indirectly, cause property damage, injury or loss of lives. As such, we could, amongst others, be subjected to one or more of the following:-

- (a) issued with stop-work order;
- (b) suspension or revocation of our licences and permits;
- (c) fined; and
- (d) subjected to legal proceedings.

The occurrence of any one or more of the above events may affect our business operations as well as financial performance. For the past four (4) FYE 2011 to FYE 2014 and up to the LPD, we have not experienced any claims for defective works.

We adopt the following procedures and processes to ensure at all times a high standard of product quality, performance and safety:-

- (i) We have standard operating procedures and processes (SOPP) for all key aspects of our work. Our SOPP are constantly reviewed and improved;
- (ii) We have ISO 9001:2008 Quality Management System in place to help us maintain a high standard of product quality. We are subjected to yearly audit for our ISO 9001:2008 certification;
- (iii) We have qualified in-house professionals, including Engineers, to help ensure that our products meet various quality and performance standards and specifications; and

3. RISK FACTORS (Cont'd)

- (iv) Our works are also subjected to audit and quality check, and ultimately approval by our clients.

Nevertheless, there can be no assurance that we will not encounter any product defects that may impact our operations or financial performance.

3.1.5 We Rely on Subcontractors for Our Projects

We have used subcontractors to supply labour to us and to perform earthworks, excavation and disposal of excavated earth for our projects. We use subcontractors to complement our in-house resources particularly for labour-intensive functions, as well as to perform specialised works that are not part of our core competencies.

There is a risk that our projects may be delayed, experience cost overruns or poor quality of work attributed to our subcontractors. Some of the possible negative factors attributable to subcontractors include, amongst others, the following:-

- (a) insufficient availability of resources at the required time;
- (b) poor skills level; and
- (c) unanticipated cost escalation.

For FYE 2011 to FYE 2014, we have not experienced any material impact from our reliance on subcontractors that caused us to pay liquidated damages cost. It is also common for operators in our industry to use subcontractors to supplement their in-house resources and skills base.

We adopt the following procedures in our selection and use of subcontractors:-

- (i) Our preference is to use subcontractors that have a track record of quality, timely and reliable service working with us;
- (ii) Part of our selection criteria includes checks on the subcontractors' registration with CIDB;
- (iii) We adopt a selection process which includes checks on financial strengths, appropriate skills base, availability of human resources, track record, market reputation and work references before we engage the subcontractor;

We commonly have multiple subcontractors for any one category of requirements to mitigate overdependence; and

- (iv) We have contractual agreements with our subcontractors with appropriate penalty clauses for failure in the provision of agreed services in a timely manner.

Nevertheless, there is no assurance that we will be able to avoid adverse impact from the use of subcontractors. Failure by subcontractors to perform according to contractual agreements and expectations may have an adverse impact on the financial performance of our Group.

[THE REST OF THIS PAGE IS INTENTIONALLY LEFT BLANK]

3. RISK FACTORS (Cont'd)

3.1.6 We Are Dependent on Foreign Workers

We use many foreign workers directly and indirectly for our projects. As at the LPD, we have 372 foreign workers that we hire directly. Our subcontractors also use a large number of foreign workers in the performance of work for our projects.

There is a risk that our dependency on foreign workers may adversely affect our financial performance under the following circumstances, amongst others:-

- (a) insufficient general and skilled labour to complete our projects on time;
- (b) increase in the cost of foreign workers, which directly affects our overall project cost;
- (c) drop in quality of work due to inadequate training and high worker turnover; and
- (d) changes in government policies and regulations affecting the supply and cost of hiring foreign workers.

Save as disclosed in Section 3.1.3(a) for the impact of insufficient supply of labour which resulted in delay in the completion of our project, we have not experienced other material negative effect from our dependency on foreign workers during the FYE 2011 to FYE 2014 and up to the LPD.

We use a combination of direct hire of foreign workers and multiple sources of supply of foreign workers from third party agencies and subcontractors to minimise situations where we are short of foreign workers. In addition, foreign workers hired directly by us undergo a period of training and are constantly supervised at the work site to ensure compliance to our quality standards, procedures and expectations.

Nevertheless, there is no assurance that we will continue to have adequate supply of foreign workers or that the quality of work performed by foreign workers is in compliance to our client's standard of quality and expectation. Any failure in quality of work and timely completion of projects may have an adverse impact on the financial performance of our Group.

3.1.7 Our Insurance Coverage May Be Inadequate

As at the LPD, we have insurance coverage including:-

- (a) Contractor's all risk insurance for our ongoing projects, where required, other than those projects for which such insurance has already been provided for/ obtained by the relevant project owners or main contractors;
- (b) Workmen compensation insurance for our ongoing projects, where required, other than those projects for which such insurance has already been provided for/ obtained by the relevant project owners or main contractors;
- (c) Medical/ surgical insurance for all of our staff;
- (d) Personal accident insurance for all of our staff;
- (e) Fire insurance for our office buildings;
- (f) Comprehensive car insurance for our motor vehicles;
- (g) Equipment all risk for our machineries;

3. RISK FACTORS (Cont'd)

- (h) Foreign Workers Compensation Scheme for our foreign workers; and
- (i) Medical insurance for our foreign workers.

There is a risk that in the event of a mishap, we may not have adequate or appropriate insurance coverage to compensate us for any subsequent losses due to the mishap. If this situation arises, it will have an impact on our financial performance.

For the FYE 2011, FYE 2012 and FYE 2014 we received insurance payout related to our construction work and machinery as set out below:-

- (i) For FYE 2011, we received insurance payout of approximately RM111,000 due to repair work caused by an accident in relation to the Paradigm Mall, Kelana Jaya project;
- (ii) For FYE 2012, we received insurance payout of approximately RM261,000 in relation to the overturning of our piling machine used for the Tabung Haji office complex project in Putrajaya; and
- (iii) For FYE 2014, we received insurance payout of approximately RM34,000 in relation to the loss of our machinery due to theft.

There was no insurance payout received by us for the FYE 2013.

We review the adequacy of our insurance requirements for our plant and machinery as and when required. In addition, we continue to review our other insurance policies to ensure that the relevant plant and machinery, and projects are insured and covered, such as contractors' all risk insurance, fire insurance, workers' insurance and public liability insurance to manage any losses which may arise.

Nevertheless, there can be no assurance that our insurance coverage is adequate and appropriate, and that any mishaps will not have a material impact on our business performance.

3.1.8 We May Suffer Financial Distress Resulting from Our Borrowings and Financing Instruments

Our bank and trade facilities consist of hire purchase facilities, bank overdrafts, term loans, banker acceptances, trust receipts and factoring. For the FYE 2014, our total borrowings consist of hire purchase facilities, bank overdrafts, term loans, banker acceptances, trust receipts and factoring amounted to a total of approximately RM77.20 million. All our borrowings are interest bearing, denominated in RM and borrowed from locally-based financial institutions. In addition, our finance costs mainly comprised interest charged on bank and trade facilities increased from approximately RM1.25 million for FYE 2011 to approximately RM5.28 million for FYE 2014.

There is a risk that we may not be able to meet our borrowing commitments or breach covenants imposed by the financial institutions. In addition, the interest rates of our borrowings may increase. If any of these circumstances occurs, we may not be able to meet our borrowing commitments or our financial performance may be affected.

For the past four (4) FYE 2011 to FYE 2014, we paid overdue interests which were of negligible amounts and represented less than 1% of our Group's total finance costs.

3. RISK FACTORS (Cont'd)

In July 2014, BNM increased the Overnight Policy Rate by 25 basis points, which subsequently caused our borrowings based on floating rates to increase by the same amount. In the scenario of a further interest rate hike, most businesses would be affected by higher borrowing costs, including the construction sector. As at 31 December 2014, our Group's gearing ratio stood at approximately 0.72 times. Out of approximately RM77.20 million of the total outstanding bank borrowings of our Group as at 31 December 2014, approximately RM50.59 million were floating rate borrowings. As such, our Group's financial position, cash flow and profitability could be negatively impacted by any increase in the costs of borrowing as a result of an interest rate hike. We aim to reduce our gearing ratio by reducing borrowings relative to shareholders' equity. Amongst others, we aim to use part of our Public Issue proceeds to reduce some of our bank borrowings. Our Group has set aside RM12.0 million of the Public Issue proceeds to pare down part of our Group's existing bank borrowings. This would effectively reduce our Group's gearing ratio as at 31 December 2014 from approximately 0.80 times to approximately 0.40 times. In addition, our Company will be able to access funds from the local equity market subsequent to our Listing. Funding from the equity market is not based on interest, thus mitigating any interest rate hikes. However, it is our business strategy to continue to use borrowings, amongst other sources of funds, for our operations as well as for business development and growth.

Nevertheless, there can be no assurance that our borrowing obligations will not cause us to suffer financial distress or adversely affect our financial performance.

3.1.9 We Are Subjected to Early Termination of Our Contracts

All of our projects are based on contractual agreements. There may be risks in early termination of our contracts as a result of one or more of the following situations, amongst others:-

- (a) Suspension or scrapping of the entire project affecting our portion of the work to be done;
- (b) Termination of the services of the main contractor where we are part of its pool of subcontractors; and
- (c) We are in breach of certain aspects of our work performance or contractual agreement.

Any early termination of our contracts may have an impact on our financial performance as we may have committed resources to the project or are unable to obtain compensation for the work we have performed.

For the FYE 2011 to FYE 2014 and up to the LPD, we have not encountered early or abnormal termination of our contracts.

Our contracts would normally state conditions for early termination and the compensation due to us under the respective conditions. In addition, we adopt the following procedures to minimise occurrence of early termination of our contracts:-

- (i) We work with reputable main contractors and project owners;
- (ii) We undertake our own due diligence on customers that we have not worked with before; and
- (iii) We comply with the scope of work set out in each of our contracts and put in place procedures and safeguards to avoid any breach of contract.

Nevertheless, there can be no assurance that we may not experience early termination of our contracts which will affect our financial performance.

3. RISK FACTORS (Cont'd)

3.1.10 We Are Reliant on Our Directors and Key Management Personnel

We are reliant on our Directors and key management personnel for the smooth operation of our business as well as to further develop and grow our business.

There is a risk that the departure of one or more Directors and key management personnel will affect our business operations and future growth.

In mitigation, we have in place contingencies and succession planning, where each of the following key positions has one or more successor-in-training:-

- (a) Group Managing Director;
- (b) Chief Financial Officer;
- (c) Head of Plant Division;
- (d) Senior Project Manager; and.
- (e) Senior Contracts Manager.

As part of our contingency and succession planning, we also have in place on-the-job training, in-house training and external training.

Nevertheless, there can be no assurance that despite our contingency and succession planning, the departure of one or more Directors or key management personnel would not materially affect our business operation and development, and financial performance.

3.1.11 We Face Competition from Other Piling Contractors

We face competition from other piling contractors in the industry. As at 30 April 2015, there were approximately 5,709 operators registered with CIDB under the category of Piling Works for Civil Engineering Construction of which 2,211 operators were registered with grade G7. Furthermore, there were approximately 996 operators registered with CIDB under the category of Piling Works for Building Construction of which 372 operators are registered with grade G7. Generally, competition among piling contractors will be somewhat moderated by operators with competitive advantages including a high degree of integration in terms of evaluation, design, construction, engineering consultancy and engineering services to facilitate better quality and cost control.

(Source: Independent Assessment of the Piling, Foundation and Construction Industry for Infrastructure and Buildings in Malaysia prepared by Vital Factor)

Despite the numerous operators that increase the intensity of competition, we are able to leverage on our competitive strengths as specialists in bore piling supported by our in-house design and engineering capabilities, our experience in the engineering and construction business for approximately 20 years, our own fleet of machinery and equipment, our qualified and experienced management and technical team as well as our quality management systems and our safety track record in place. Whilst we strive to remain competitive, there can be no assurance that any change in the competitive environment would not have a material and adverse impact on our operational and financial performance.

[THE REST OF THIS PAGE IS INTENTIONALLY LEFT BLANK]

3. RISK FACTORS (Cont'd)**3.1.12 Our Operations May Be Affected by the Risk of Relocations**

Our Group currently operates from two (2) of our own properties that are not in compliance with the relevant laws, regulations, rules and requirements as set out below:-

No.	Address	Existing Use	Submission to Address
(a)	Nos. 35, 37 & 39 Jalan PJU 1A/41B Pusat Dagangan NZX Ara Jaya, PJU 1A 47301 Petaling Jaya Selangor Darul Ehsan	Our Group's head office	Submitted an application to Majlis Bandaraya Petaling Jaya to obtain approval for the extension and renovation on 4 July 2014 and as at the LPD, the approval is still pending. Please refer to note (1) in Section 4.14.2 of this Prospectus for further details
(b)	Lot 4907, Jalan Segenting Batu 11, Kuala Langat 42500 Teluk Panglima Garang Selangor Darul Ehsan	Storage and maintenance area for our Group's construction materials and equipment for our ongoing construction activities before they are transferred to our respective working sites	Submitted an application to Majlis Daerah Kuala Langat to obtain planning approval for the temporary building on 24 October 2014 and as at the LPD, the approval is still pending. Please refer to note (2) in Section 4.14.2 of this Prospectus for further details

Our appointed architect/ consultant had submitted applications on our behalf to the relevant authorities to obtain the necessary approvals and to address the non-compliances as disclosed above. The details of the non-compliances, the status of approvals from the relevant authorities and the expected timeline to obtain the approvals are disclosed in notes (1) and (2) of Section 4.14.2 of this Prospectus.

There can be no assurance that we would be able to obtain the necessary approvals for these properties despite our efforts to ensure that the applications meet all the necessary requirements of the relevant authorities. In the event that we are unable to obtain the necessary approvals from the relevant authorities, our Group intends to temporarily shift our head office (as disclosed in Section 3.1.12(a) of this Prospectus) and our storage and maintenance area for construction materials and equipment (as disclosed in Section 3.1.12(b) of this Prospectus) to new locations to be identified for the necessary rectification works to be performed on the properties until all relevant laws, regulations, rules and requirements are fully complied with. We will ensure to the extent possible, that the premises identified for the aforementioned relocations have all the relevant approvals in place in compliance with the relevant laws, regulations, rules and requirements.

As such, our Group is susceptible to relocation risk if our Group is not able to obtain the necessary approvals from the relevant authorities. In the event of relocations, additional costs will be incurred by our Group in relation to the relocations and rentals, and we may encounter disruptions in our administrative and business operations for approximately two (2) months during the relocation period.

[THE REST OF THIS PAGE IS INTENTIONALLY LEFT BLANK]

3. RISK FACTORS (Cont'd)

3.2 RISKS RELATING TO THE INDUSTRY IN WHICH OUR GROUP OPERATES

3.2.1 Fluctuation in Prices of Major Building and Construction Materials

Our business and financial performance are subject to fluctuation in the prices of building and construction materials. For the FYE 2014, building and construction materials accounted for approximately 49.52% of our Group's purchases of materials, consumables and services.

The major building and construction materials are cement and concrete materials, as well as iron and steel materials. As these building and construction materials are commodities, their prices are subjected to the fluctuation in global market prices. In the event of a sustained increase in the prices of these building and construction materials, there is a risk that we may not be able to pass such price increases to our customers without adversely affecting our price competitiveness. Under such scenarios, price increases for major building materials may adversely affect our financial performance.

However, operators who are able to enter into long-term or fixed-price contracts with their key suppliers are in a better position to mitigate against any risk of price increases for major building and construction materials. Operators who are financially strong may be able to purchase and maintain stocks of key raw materials to cushion against price fluctuation. Nevertheless, as these building and construction materials are commodities and therefore are subjected to world prices, all operators using these materials are equally affected by price fluctuation.

3.2.2 Property Overhang

Our business is dependent on factors affecting the property market, including the risk of a property overhang situation. Property overhang is commonly due to an oversupply of new launches relative to the demand for new property. A persistently high level of unsold property or an increase in property overhang will have an impact on property developments where there may be a decrease in demand for properties. This in turn may indirectly have an impact on the operators within the Piling, Foundation and Construction Industry.

The Malaysian Government had implemented measures to ensure stability in housing prices and to control speculative activity in the property development sector. These measures that are applicable to residential and commercial properties include, amongst others, the upward revision of the Real Property Gains Tax, tightening of the lending policies, prohibition on property developers from implementing projects that have features of Developers Interest Bearing Scheme (DIBS) and increase in the minimum price of property that can be purchased by foreign individuals and companies. Nevertheless, between 2010 and 2014, the number of residential property and shop units overhang in Malaysia decreased at a compound annual rate of 15.5% and 6.0% respectively. This indicates that the property overhang situation has been improving.

(Source: Independent Assessment of the Piling, Foundation and Construction Industry for Infrastructure and Buildings in Malaysia prepared by Vital Factor)

[THE REST OF THIS PAGE IS INTENTIONALLY LEFT BLANK]

3. RISK FACTORS (Cont'd)

3.2.3 Implementation of Goods and Services Tax

Our Group may be affected by the impending implementation of Goods and Services Tax ("GST"). In the Budget 2014, the Government announced that the existing sales tax and service tax will be abolished and will be replaced by GST which was effective from 1 April 2015 onwards. The Malaysian Goods and Services Tax Act 2014 was gazetted on 19 June 2014. The GST will be applied to all goods and services unless they are not within the scope of GST. For the construction sector, the implementation of GST may impact on the selling price of the constructed products.

(Source: Independent Assessment of the Piling, Foundation and Construction Industry for Infrastructure and Buildings in Malaysia prepared by Vital Factor)

Subsequent to the implementation of GST in April 2015, all the input components of our Group's construction cost have been subjected to the 6% tax rate. For the FYE 2014, approximately 50% of our Group's construction cost was subjected to the existing 10% sales and service tax ("SST"). Hence, the SST imposed on our Group's total construction cost was effectively 5%. As such, the tax amount for GST at a rate of 6% would be higher by 1% than the existing average SST imposed, hence marginally impacting our Group.

The GST is however a broad base tax and all operators in the Piling, Foundation and Construction Industry will be equally affected. In addition, it is likely that operators will be able to pass the cost on to project owners and/or main contractors by incorporating the GST cost into their contracts.

Nevertheless, there can be no assurance that the implementation of GST will not materially impact our future business and financial performance.

3.2.4 Political, Economic and Regulatory Uncertainties

Our Group's business is primarily subject to prevailing economic, political and regulatory conditions. Any adverse developments in the political, economic and regulatory environment including prolonged and/or widespread economic slowdown in Malaysia would affect our business and profitability. Any uncertainty in the global and local economies would have an effect on the level of investments in the private sector, which will correspondingly have a negative impact on construction activities in Malaysia.

We may be affected by any change in the political leadership and/or regulatory and government policies relating to the construction industry in Malaysia. Such political and/or regulatory changes and uncertainties include, but are not limited to, the introduction of new or revised laws and regulations which may impact and/or impose restrictions on the construction industry, political developments, risk of war, expropriation, nationalisation, financial and banking policies and guidelines, and renegotiation or nullifying of contracts. Similarly, any widespread and/or prolonged economic slowdown would affect business and consumer confidence, and subsequently affect the tendency to spend, either from the public or private sector.

[THE REST OF THIS PAGE IS INTENTIONALLY LEFT BLANK]

3. RISK FACTORS (Cont'd)

3.3 RISKS RELATING TO THE IPO

3.3.1 No Prior Market for Our Shares

Prior to this invitation, there has been no public market for our Shares. There can be no assurance that an active market for our Shares will develop and continue to develop upon or subsequent to our Listing or, if developed, that such a market can be or will be sustained. The IPO Price has been determined after taking into consideration a number of factors, including but not limited to our Group's financial and operating history and conditions, our prospects and the prospects of the industry in which our Group operates, the management of our Group, the market price for shares of companies engaged in similar businesses and the prevailing market conditions.

There can be no assurance that the IPO Price will correspond to the market price at which our Shares will be traded on the Main Market of Bursa Securities upon or subsequent to our Listing or that an active market for our Shares will develop or continue to develop upon or subsequent to our Listing.

3.3.2 Capital Market Risks/ Share Price Volatility

The performance of the local bourse is very much dependent on external factors such as the performance of the regional and world bourses, and the flow of foreign funds. Sentiments are also driven by internal factors such as political and economic conditions. These factors invariably contribute to the volatility of the local bourse. Our Shares upon Listing will be subjected to the vagaries of the Malaysian capital markets. Nevertheless, the profitability of our Group is not dependent on the performance of Bursa Securities as the business activities of our Group have no direct correlation with the performance of Bursa Securities.

The market price of our Shares may fluctuate significantly and rapidly in response to, *inter alia*, the following factors, some of which are beyond our control:-

- (a) variations in our operating results;
- (b) changes in securities analysts' recommendations, perceptions or estimates of our financial performance or future prospects;
- (c) changes in market valuations and share prices of companies with similar businesses to our Company that may be listed in Malaysia;
- (d) announcements by us of significant acquisitions, disposals, strategic alliances or joint ventures;
- (e) fluctuation in stock market prices and trading volumes;
- (f) our involvement in material litigations;
- (g) additions or departures of key personnel;
- (h) success or failure of our management in implementing business and growth strategies; and
- (i) changes in conditions affecting the industries in which we operate, general economic conditions or stock market sentiments.

3. RISK FACTORS (Cont'd)

3.3.3 Control by Our Promoters

Upon our Listing, our Promoters will hold approximately 65.19% of our enlarged issued and paid-up share capital as set out in Section 6.1.1 of this Prospectus. As a result, they will still be able to, in the foreseeable future, effectively control the business direction and management of our Group as well as influence the outcome of certain matters requiring the voting of our shareholders unless our Promoters are required to abstain from voting by law and/or by the relevant guidelines or regulations.

Nevertheless, as a step towards good corporate governance, we have appointed four (4) Independent Directors and set up an Audit and Risk Management Committee to ensure that, *inter alia*, all future transactions involving related parties, if any, are entered into on an arm's length basis, normal commercial terms that are not more favourable to the related parties than those generally available to third parties and are not to the detriment of our minority shareholders.

3.3.4 Payment of Dividends

The availability of funds for our Group to pay dividends or make other distributions to our shareholders depends upon our financial performance and the dividends or other distributions received from our subsidiaries.

The incurrence of debts or losses by our Company or our subsidiaries will restrict our ability to pay dividends. In addition, restrictive covenants in financial institutions credit facilities or other agreements that we or our subsidiaries may enter into in the future may also restrict our ability to pay dividends and make other distributions to our shareholders.

Our ability to pay dividends or make other distributions to our shareholders is also subject to our Group's future financial performance and cash flow position. There is no assurance that we will be able to record profits and have sufficient funds over and above our funding requirements, other obligations and business plans, to declare dividends or make other distributions to our shareholders. Accordingly, our historical dividend distributions should not be used as a reference or basis to determine the level of dividends that may be declared and paid by us to our shareholders in the future.

Please refer to Section 9.7 of this Prospectus for details on our intended dividend policy.

3.3.5 Potential Delay or Failure of Our Listing

Our Listing may fail or be delayed should any of the following events occur:-

- (a) the Bumiputera investors approved by the MITI under the Private Placement fail to subscribe for the Offer Shares allocated to them;
- (b) our Underwriter exercises its rights pursuant to the Underwriting Agreement to discharge itself from its obligations thereunder;
- (c) the selected investors under the Private Placement fail to subscribe for the IPO Shares allocated to them;
- (d) our Company is unable to meet the public spread requirements, i.e. at least 25.0% of the total enlarged issued and paid-up share capital of our Company must be held by a minimum of one thousand (1,000) public shareholders holding not less than one hundred (100) Shares each in our Company at the point of Listing; and
- (e) unfavourable market conditions, which may give rise to a low subscription rate for the IPO Shares or a depressed share price upon Listing.

3. RISK FACTORS (Cont'd)

We will endeavour to comply with the Listing Requirements and SC Guidelines whichever is applicable and relevant to the above factors. However, there can be no assurance that the abovementioned factors and/or events will not cause a delay in or abortion of our Listing.

3.3.6 Delay between Admission and Trading of the IPO Shares

After the IPO Shares have been allotted and/or allocated to the respective investors' CDS accounts maintained with Bursa Depository, which would occur at least two (2) clear Market Days prior to the anticipated date for the Listing, it may not be possible to recover monies paid in respect of the IPO Shares from us in the event the Listing and the commencement of trading on the Main Market of Bursa Securities do not occur.

Delays in listings and commencement of trading in shares on Bursa Securities have occurred in the past. In respect of the Public Issue Shares comprised in the IPO Shares, following their allotment and issuance to investors, a return of monies to such investors may be effected by way of a reduction of our share capital. A capital reduction would require the approval by special resolution of our shareholders as well as approval by the High Court of Malaya.

Further, such capital reduction shall not be effected if on the date the reduction is to be effected, there are reasonable grounds for believing that we are, or after the reduction would be, unable to pay our liabilities as they become due.

There can be no assurance that monies can be recovered within a short period of time, or at all. If Bursa Securities does not admit our Shares for the Listing, the market for our Shares will be illiquid and it may not be possible to trade our Shares. This may also have a materially adverse effect on the value of our Shares.

3.3.7 Disclosure Regarding Forward-Looking Statements

Certain statements in this Prospectus are based on historical data, which may not be reflective of our future results and any forward-looking statements are subject to uncertainties and contingencies. All forward-looking statements are based on estimates, forecasts and assumptions made by our Company and our Group, and although believed to be reasonable, are subject to unknown risks, uncertainties and other factors which may cause the actual results, performance or achievements of our Group to differ materially from the future results, performance and achievements expressed or implied in such forward-looking statements. Such factors include, *inter alia*, general economic and business conditions, competition and the impact of new laws and regulations affecting our Group. In the light of these and other uncertainties, the inclusion of any forward-looking statements in this Prospectus should not be regarded as a representation by our Company or our Company's adviser that the plans and objectives of our Group will be achieved.

[THE REST OF THIS PAGE IS INTENTIONALLY LEFT BLANK]

4. INFORMATION ON OUR GROUP

4.1 BACKGROUND INFORMATION

4.1.1 History and Key Milestones

4.1.1.1 History of Our Group

We were incorporated in Malaysia under the Act as a public limited company on 5 December 2013 under our present name to serve as an investment holding company and a vehicle for our Listing. Our Group's principal business activities are in engineering and construction, where we are involved in piling and foundation works, bridge construction, building construction and other civil works. Our other business activity is in the manufacture and installation of prefabricated building system. Over the years, we have established ourselves as a bore piling specialist with a track record of approximately 12 years. Bore piling is a method used in piling and foundation works.

Our Group was founded by Dato' Ang Cheng Siong, our Group Managing Director, Siew Mun Lout, our Executive Director, Dato' Ir Dr Khoo Ping Sen, our Executive Director, and Yap Yoon Fatt, our Head of Plant Division. All of our founders have been instrumental in contributing to the strategic direction, growth, development, operation and success of our Group.

The history of our business can be traced back to 1992 with the incorporation of Ikhmas Jaya where our initial activity was in general civil engineering works. In 1994, we successfully secured and commenced our first project as detailed in item 1, Section 4.1.1.2 of this Prospectus.

In 1996, we incorporated Rekavista, which served as a special purpose vehicle to undertake civil engineering and building construction projects. In 2005, Rekavista became our wholly-owned subsidiary and remained an inactive company until 2012, when we undertook piling and foundation works for the KL Eco City Parcel C project. In 1997, we incorporated Aliran Ribuan Sdn Bhd (now known as MM2 Builders) and only commenced business in 1999 as a manufacturer of concrete products. In June 2014, MM2 Builders changed its business activity to the installation of prefabricated building system to support the business operations of MM2 Building System. Also in 1997, we were awarded two (2) contracts to construct bridges within Putrajaya as detailed in item 2, Section 4.1.1.2 of this Prospectus, which provided us with the track record to secure other bridge construction projects.

In 1999, we incorporated RV Equipment Sdn Bhd (now known as Ikhmas Equipment) to provide rental service of construction machinery and equipment for in-house use as well as for external customers. In 2000, we incorporated Rekavista Sarawak to undertake general civil and building construction works in Sarawak. Rekavista Sarawak secured and commenced its first project in 2002 as detailed in item 4, Section 4.1.1.2 of this Prospectus.

In 2003, we secured our first *building* bore piling contract, as detailed in item 5, Section 4.1.1.2 of this Prospectus. In 2004, we purchased our first bore piling machine as we aim to expand our bore piling and foundation business. Prior to that, we were renting machinery and equipment. With our own machinery and equipment, we have since been able to better control our work schedule by minimising dependency on third party supplier of machinery and equipment.

In 2004, we incorporated IJ Geotechnic to undertake geotechnical works and provide CSM technology, which are complementary to our bore piling and foundation works. Geotechnical works commonly precede any piling and foundation works. In addition, planning and specification for piling and foundation works, including, amongst others, the type of piling, number of piles, dimension of piles and depth of piling, are dependent on geotechnical studies and works. CSM technology is a complementary technology used in constructing retaining walls.

4. INFORMATION ON OUR GROUP (Cont'd)

In 2006, we undertook piling and foundation works for an administration complex in Putrajaya as detailed in item 7, Section 4.1.1.2 of this Prospectus. We adopted the project owner's Environmental Management System processes and practices, and were subsequently awarded a certificate of recognition for implementing "Best Environmental Management System". This recognition will provide us with an advantage when bidding for future jobs from the project owners.

In 2010, we undertook the design and construction of Prai Swing Bridge in mainland Penang as detailed in item 10, Section 4.1.1.2 of this Prospectus. We received nationwide recognition for this project when it was awarded the IEM Outstanding Engineering Achievement Award by The Institution of Engineers Malaysia in 2014.

In 2012, we incorporated MM2 Building System and ventured into the manufacture of prefabricated building system using the proprietary "M2 EMMEDUE® Advanced Building System" machinery and equipment from our supplier, EMMEDUE® S.p.A. in Italy. As at the LPD, MM2 Building System together with its supporting arm MM2 Builders are undertaking two (2) ongoing projects with a total of approximately RM61 million. During the same year in 2012, we undertook piling and substructure works for Parcel C of the KL Eco City project at Bangsar, Kuala Lumpur as detailed in item 11(a), Section 4.1.1.2 of this Prospectus. For this project, we proposed an alternative design using a CSM wall to replace the specified diaphragm wall system. Our CSM wall design saved two (2) months in construction time and approximately RM2.7 million in project cost as compared to the original tender specification which has resulted in our successful securing of the project. In addition, it was our maiden project using CSM technology.

In 2013, we undertook building construction works for a service apartment in Ampang, Kuala Lumpur as detailed in item 12(a), Section 4.1.1.2 of this Prospectus. In the same year, we undertook our largest project to-date based on contract value. This was for infrastructure works for the Subang-Skypark Terminal Railway Track project as detailed in item 12(b), Section 4.1.1.2 of this Prospectus.

Since 2003, we have made a concerted effort to establish ourselves as specialists in bore piling. For FYE 2014, our Group achieved revenue of approximately RM293.51 million.

4.1.1.2 Key Project Milestones of Our Group

Our Group's key project milestones are summarised as follows:-

No.	Year of Commencement	Projects	# Total Contract Value (RM' million)
1.	1994	Ikhmas Jaya secured and commenced our first project for the design, construction and commissioning of water pipe laying works from Sentul Hill Reservoir to Kuala Lumpur City Centre Development Area which was completed in 1995	10
2.	1997	Ikhmas Jaya was awarded two (2) contracts to construct bridges within Putrajaya as follows:- (a) Bridge BR 10; and (b) Putra Bridge; which both were completed in 1999	37 57
3.	2001	Ikhmas Jaya secured a contract for the construction of a bridge at Chenor, Pahang which was completed in 2004	85

4. INFORMATION ON OUR GROUP (Cont'd)

No.	Year of Commencement	Projects	# Total Contract Value (RM' million)
4.	2002	Rekavista Sarawak secured and commenced its first project for the construction of a secondary school in Sibul, Sarawak which was completed in 2004	17
5.	2003	Ikhmas Jaya secured our first building bore piling contract for the construction of a diaphragm wall for Prince Court Medical Centre, a private hospital in Kuala Lumpur which was completed in the same year	19
6.	2004	Ikhmas Jaya secured our first infrastructure bore piling project for the construction of contiguous bored pile walls for the Gombak River Diversion flood mitigation project in Kuala Lumpur which was completed in 2006	37
7.	2006	Ikhmas Jaya undertook piling and foundation works for an administration complex, "Pusat Pentadbiran Kerajaan Persekutuan", in Precinct 5, Putrajaya which was completed in 2008	72
8.	2008	Ikhmas Jaya commenced piling and foundation works for Paradigm Mall in Kelana Jaya, Selangor	30
9.	2009	Ikhmas Jaya undertook the following:- (a) the design-and-build building construction of a training centre for the Royal Malaysia Police (PULAPOL) in Terengganu; and (b) the infrastructure works, ground improvement, bridge structures, drainages, road works, landscape and associated works for JB-Nusajaya Highway – Section 2: CH 2400 to CH 9500 which was completed in 2011	112 49
10.	2010	Ikhmas Jaya undertook the design and construction of the Prai Swing Bridge in mainland Penang for the railway electrification and double tracking project from Ipoh to Padang Besar which was completed in August 2013	80
11.	2012	(a) Rekavista undertook contiguous bored pile wall, earthworks, piling and basement structure works for Parcel C of the KL Eco City project at Bangsar, Kuala Lumpur which was completed in May 2014; (b) Ikhmas Jaya secured an additional contract for the substructure works and elevated roadway for Parcel D of the KL Eco City project; and (c) Ikhmas Jaya was awarded a contract to undertake bore piling, caisson piles and micro piles works for Package V8 of the Klang Valley Mass Rapid Transit Sungai Buloh-Kajang Line project in Selangor	153 109 98
12.	2013	(a) Ikhmas Jaya undertook superstructure and other finishing works including M&E and interior design works for Damai 88 service apartments in Ampang, Kuala Lumpur; and (b) Ikhmas Jaya undertook infrastructure works for Subang-Skypark Terminal Railway Track – Phase 1, a railway project between Saujana and Skypark Terminal in Subang	111 270

4. INFORMATION ON OUR GROUP (Cont'd)

Note:-

Total contract value includes variations orders.

Save as disclosed in Sections 4.1.1.1 and 4.1.1.2 above, there were no material changes in the mode of conducting our Group's business and there were no material changes in the types of products produced or services rendered in the course of our Group's history up to the LPD.

Save as disclosed in Section 4.14.6 of this Prospectus, there were no acquisitions or disposals of material assets other than in the ordinary course of our business for the past four (4) FYE 2011 to FYE 2014 and up to the LPD.

Our Group has never been involved in any bankruptcy, receivership or similar proceedings.

Please refer to Section 4.4.1 for the awards and recognition of our Group.

4.1.2 Share Capital and Changes in Share Capital

Our present authorised share capital is RM250,000,000 comprising 1,000,000,000 Shares, of which RM98,500,000 comprising 394,000,000 Shares have been issued and fully paid-up.

Details of the changes in our issued and paid-up share capital since incorporation are as follows: -

Date of Allotment	No. of Shares Allotted	Par Value (RM)	Consideration	Cumulative Issued and Paid-up Share Capital (RM)
05.12.2013	2	1.00	Subscribers' shares	2
25.04.2014	98	1.00	Cash	100
07.05.2015	300	0.25	Subdivision	100
03.06.2015	393,999,600	0.25	Shares issued as consideration for the Acquisition of Ikhmas Jaya	98,500,000

Upon completion of the Public Issue, our enlarged issued and paid-up share capital will be increased to RM130,000,000 comprising 520,000,000 Shares.

None of Ikhmas Berhad's shares as tabulated above were issued at a discount, on special terms or instalment payment terms. As at the LPD, there are no outstanding warrants, options, convertible securities or uncalled capital of Ikhmas Berhad.

[THE REST OF THIS PAGE IS INTENTIONALLY LEFT BLANK]

4. INFORMATION ON OUR GROUP (Cont'd)

4.1.3 Corporate Structure

As at the LPD, our corporate structure is as follows:-

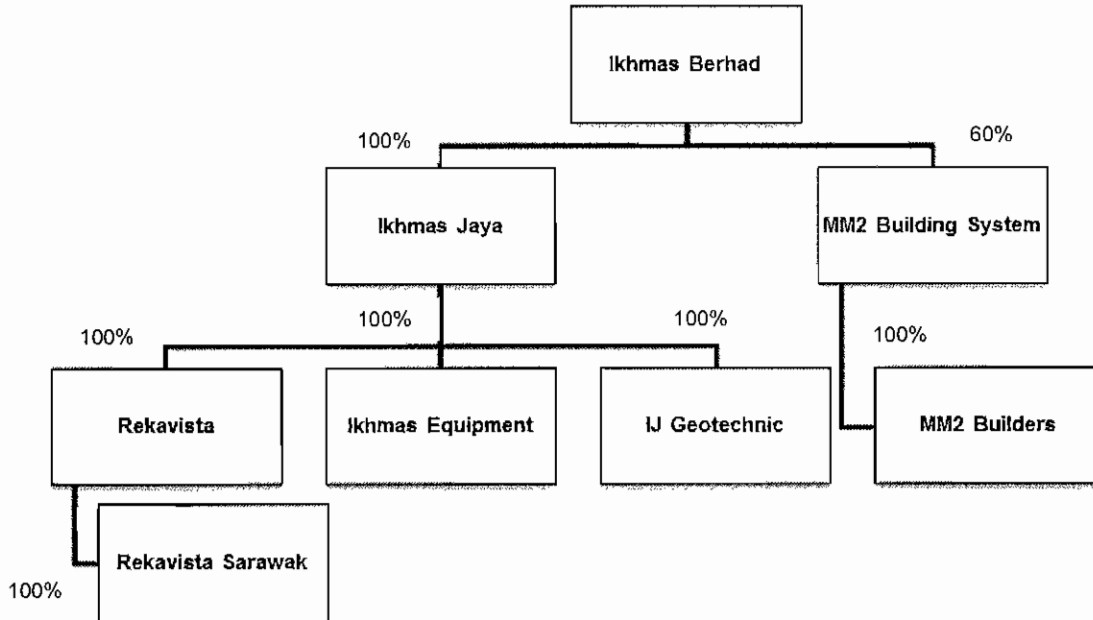

The details of our subsidiaries are as follows:-

Corporation	Date/ Place of Incorporation	Issued and Paid-up Share Capital (RM)	Equity Interest (%)	Principal Activities
Ikhmas Jaya	12.12.1992/ Malaysia	30,000,000	100.0	Piling and foundation works, construction of bridges and buildings, and other civil works
MM2 Building System	21.06.2012/ Malaysia	401,000	60.0	Manufacture of prefabricated building system
<i>Subsidiaries held by Ikhmas Jaya</i>				
Rekavista	14.06.1996/ Malaysia	2,000,000	100.0	General civil and building construction
Ikhmas Equipment	08.10.1999/ Malaysia	2	100.0	Rental of plant, machinery and equipment
IJ Geotechnic	02.07.2004/ Malaysia	2	100.0	Geotechnical works and provision of CSM technology
<i>Subsidiary held by MM2 Building System</i>				
MM2 Builders	05.11.1997/ Malaysia	100,000	100.0	Installation of prefabricated building system
<i>Subsidiary held by Rekavista</i>				
Rekavista Sarawak	23.06.2000/ Malaysia	100	100.0	General civil and building construction

4. INFORMATION ON OUR GROUP (Cont'd)

4.1.4 Our Subsidiaries

4.1.4.1 Ikhmas Jaya

(a) Background and History

Ikhmas Jaya was incorporated in Malaysia under the Act on 12 December 1992 as a private limited company under the name of Ikmas Jaya Sdn Bhd. It changed and assumed its present name on 28 September 1994.

Ikhmas Jaya commenced business on 1 September 1994.

(b) Principal Activities and Products/ Services

Ikhmas Jaya is principally engaged in piling and foundation works, construction of bridges and buildings, and other civil works.

(c) Substantial Shareholder

Ikhmas Jaya is a wholly-owned subsidiary of our Company.

(d) Share Capital

The authorised share capital of Ikhmas Jaya is RM50,000,000 comprising 50,000,000 ordinary shares of RM1.00 each. The issued and fully paid-up share capital of Ikhmas Jaya as at the LPD is RM30,000,000 comprising 30,000,000 ordinary shares of RM1.00 each.

The changes in the issued and fully paid-up share capital of Ikhmas Jaya since its incorporation are as follows:-

Date of Allotment	No. of Ordinary Shares Allotted	Par Value (RM)	Consideration	Cumulative Issued and Paid-up Share Capital (RM)
12.12.1992	2	1.00	Subscribers' shares	2
25.11.1994	249,998	1.00	Cash	250,000
03.06.1996	750,000	1.00	Bonus shares issued on the basis of 3 new ordinary shares for every one (1) existing ordinary shares held	1,000,000
11.06.2001	4,000,000	1.00	Bonus shares issued on the basis of four (4) new ordinary shares for every one (1) existing ordinary shares held	5,000,000
28.09.2007	15,000,000	1.00	Bonus shares issued on the basis of three (3) new ordinary shares for every one (1) existing ordinary shares held	20,000,000
25.03.2011	10,000,000	1.00	Bonus shares issued on the basis of one (1) new ordinary shares for every two (2) existing ordinary shares held	30,000,000

None of Ikhmas Jaya's shares as tabulated above were issued at a discount, on special terms or instalment payment terms. As at the LPD, there are no outstanding warrants, options, convertible securities or uncalled capital of Ikhmas Jaya.

4. INFORMATION ON OUR GROUP (Cont'd)

(e) Subsidiaries and Associates

As at the LPD, Ikhmas Jaya's subsidiaries are Rekavista, Ikhmas Equipment and IJ Geotechnic. Ikhmas Jaya does not have any associated company.

4.1.4.2 MM2 Building System

(a) Background and History

MM2 Building System was incorporated in Malaysia under the Act on 21 June 2012 as a private limited company under its present name.

MM2 Building System commenced business on 21 June 2012.

(b) Principal Activities and Products/ Services

MM2 Building System is principally engaged in manufacture of prefabricated building system.

(c) Substantial Shareholders

MM2 Building System is a 60.0% owned subsidiary of our Company.

The substantial shareholders of MM2 Building System are as follows:-

Name	Direct		Indirect	
	No. of Ordinary Shares of RM1.00 Held	(%)	No. of Ordinary Shares of RM1.00 Held	(%)
Ikhmas Berhad	240,600	60.00	-	-
Pang Kim Leen	160,400	40.00	-	-
IJ Holdings	-	-	^(a) 240,600	60.00
Goh Kim Due	-	-	^(b) 160,400	40.00

Notes:-

(a) Deemed interested by virtue of its shareholding in Ikhmas Berhad pursuant to Section 6A of the Act.

(b) Deemed interested by virtue of the shareholding of his spouse, Pang Kim Leen pursuant to Section 134(12)(c) of the Act.

(d) Share Capital

The authorised share capital of MM2 Building System is RM1,000,000 comprising 1,000,000 ordinary shares of RM1.00 each. The issued and fully paid-up share capital of MM2 Building System as at the LPD is RM401,000 comprising 401,000 ordinary shares of RM1.00 each.

The changes in the issued and fully paid-up share capital of MM2 Building System since its incorporation are as follows: -

Date of Allotment	No. of Ordinary Shares Allotted	Par Value (RM)	Consideration	Cumulative Issued and Paid-up Share Capital (RM)
21.06.2012	1,000	1.00	Subscribers' shares	1,000
27.01.2014	400,000	1.00	Cash and machinery and tools	401,000

4. INFORMATION ON OUR GROUP (Cont'd)

None of MM2 Building System's shares as tabulated above were issued at a discount, on special terms or instalment payment terms. As at the LPD, there are no outstanding warrants, options, convertible securities or uncalled capital of MM2 Building System.

(e) Subsidiary and Associated Company

As at the LPD, MM2 Building System's subsidiary is MM2 Builders. MM2 Building System does not have any associated company.

4.1.4.3 Rekavista

(a) Background and History

Rekavista was incorporated in Malaysia under the Act on 14 June 1996 as a private limited company under its present name.

Rekavista commenced business on 1 November 1997.

(b) Principal Activities and Products/ Services

Rekavista is principally engaged in general civil and building construction.

(c) Substantial Shareholders

Rekavista is a wholly-owned subsidiary of Ikhmas Jaya, which in turn is a wholly-owned subsidiary of our Company.

(d) Share Capital

The authorised share capital of Rekavista is RM2,000,000 comprising 2,000,000 ordinary shares of RM1.00 each. The issued and fully paid-up share capital of Rekavista as at the LPD is RM2,000,000 comprising 2,000,000 ordinary shares of RM1.00 each.

The changes in the issued and fully paid-up share capital of Rekavista since its incorporation are as follows:-

Date of Allotment	No. of Ordinary Shares Allotted	Par Value (RM)	Consideration	Cumulative Issued and Paid-up Share Capital (RM)
14.06.1996	2	1.00	Subscribers' shares	2
29.12.1998	98	1.00	Cash	100
23.09.1999	999,900	1.00	Bonus shares issued on the basis of 9,999 new ordinary shares for every one (1) existing ordinary shares held	1,000,000
28.07.2004	1,000,000	1.00	Bonus shares issued on the basis of one (1) new ordinary shares for every one (1) existing ordinary shares held	2,000,000

None of Rekavista's shares as tabulated above were issued at a discount, on special terms or instalment payment terms. As at the LPD, there are no outstanding warrants, options, convertible securities or uncalled capital of Rekavista.

4. INFORMATION ON OUR GROUP (Cont'd)

(e) Subsidiary and Associated Company

As at the LPD, Rekavista's subsidiary is Rekavista Sarawak. Rekavista does not have any associated company.

4.1.4.4 Ikhmas Equipment

(a) Background and History

Ikhmas Equipment was incorporated in Malaysia under the Act on 8 October 1999 as a private limited company under the name of RV Equipment Sdn Bhd. It changed and assumed its present name on 28 January 2014.

Ikhmas Equipment commenced business in July 2000.

(b) Principal Activities and Products/ Services

Ikhmas Equipment is principally engaged in rental of plant, machinery and equipment.

(c) Substantial Shareholders

Ikhmas Equipment is a wholly-owned subsidiary of Ikhmas Jaya, which in turn is a wholly-owned subsidiary of our Company.

(d) Share Capital

The authorised share capital of Ikhmas Equipment is RM100,000 comprising 100,000 ordinary shares of RM1.00 each. The issued and fully paid-up share capital of Ikhmas Equipment as at the LPD is RM2 comprising 2 ordinary shares of RM1.00 each.

There are no changes in the issued and fully paid-up share capital of Ikhmas Equipment since its incorporation.

None of Ikhmas Equipment's shares were issued at a discount, on special terms or instalment payment terms. As at the LPD, there are no outstanding warrants, options, convertible securities or uncalled capital of Ikhmas Equipment.

(e) Subsidiary and Associated Company

As at the LPD, Ikhmas Equipment does not have any subsidiary or associated company.

4.1.4.5 IJ Geotechnic

(a) Background and History

IJ Geotechnic was incorporated in Malaysia under the Act on 2 July 2004 as a private limited company under its present name.

IJ Geotechnic commenced business on 4 July 2004.

(b) Principal Activities and Products/ Services

IJ Geotechnic is principally engaged in geotechnical works and provision of CSM technology.

(c) Substantial Shareholders

IJ Geotechnic is a wholly-owned subsidiary of Ikhmas Jaya, which in turn is a wholly-owned subsidiary of our Company.

4. INFORMATION ON OUR GROUP (Cont'd)

(d) Share Capital

The authorised share capital of IJ Geotechnic is RM100,000 comprising 100,000 ordinary shares of RM1.00 each. The issued and fully paid-up share capital of IJ Geotechnic as at the LPD is RM2 comprising 2 ordinary shares of RM1.00 each.

There are no changes in the issued and fully paid-up share capital of IJ Geotechnic since its incorporation.

None of IJ Geotechnic's shares were issued at a discount, on special terms or instalment payment terms. As at the LPD, there are no outstanding warrants, options, convertible securities or uncalled capital of IJ Geotechnic.

(e) Subsidiary and Associated Company

As at the LPD, IJ Geotechnic does not have any subsidiary or associated company.

4.1.4.6 MM2 Builders

(a) Background and History

MM2 Builders was incorporated in Malaysia under the Act on 5 November 1997 as a private limited company under the name of Aliran Ribuan Sdn Bhd and changed its name to Reka Concrete Products Sdn Bhd on 3 September 1999. On 18 June 2014, it changed and assumed its present name.

MM2 Builders commenced business on 29 October 1999.

(b) Principal Activities and Products/ Services

MM2 Builders is principally engaged in the installation of prefabricated building system.

(c) Substantial Shareholders

MM2 Builders is a wholly-owned subsidiary of MM2 Building System, which in turn is a 60.0% owned subsidiary of our Company.

(d) Share Capital

The authorised share capital of MM2 Builders is RM100,000 comprising 100,000 ordinary shares of RM1.00 each. The issued and fully paid-up share capital of MM2 Builders as at the LPD is RM100,000 comprising 100,000 ordinary shares of RM1.00 each.

The changes in the issued and fully paid-up share capital of MM2 Builders since its incorporation are as follows:-

Date of Allotment	No. of Ordinary Shares Allotted	Par Value (RM)	Consideration	Cumulative Issued and Paid-up Share Capital (RM)
05.11.1997	2	1.00	Subscribers' shares	2
12.11.1999	99,998	1.00	Cash	100,000

None of MM2 Builders' shares as tabulated above were issued at a discount, on special terms or instalment payment terms. As at the LPD, there are no outstanding warrants, options, convertible securities or uncalled capital of MM2 Builders.

4. INFORMATION ON OUR GROUP (Cont'd)**(e) Subsidiary and Associated Company**

As at the LPD, MM2 Builders does not have any subsidiary or associated company.

4.1.4.7 Rekavista Sarawak**(a) Background and History**

Rekavista Sarawak was incorporated in Malaysia under the Act on 23 June 2000 as a private limited company under its present name.

Rekavista Sarawak commenced business on 1 December 2000.

(b) Principal Activities and Products/ Services

Rekavista Sarawak is principally engaged in general civil and building construction.

(c) Substantial Shareholders

Rekavista Sarawak is a wholly-owned subsidiary of Rekavista, which in turn is a wholly-owned subsidiary of our Company.

(d) Share Capital

The authorised share capital of Rekavista Sarawak is RM100,000 comprising 100,000 ordinary shares of RM1.00 each. The issued and fully paid-up share capital of Rekavista Sarawak as at the LPD is RM100 comprising 100 ordinary shares of RM1.00 each.

The changes in the issued and fully paid-up share capital of Rekavista Sarawak since its incorporation are as follows: -

Date of Allotment	No. of Ordinary Shares Allotted	Par Value (RM)	Consideration	Cumulative Issued and Paid-up Share Capital (RM)
23.6.2000	4	1.00	Subscribers' shares	4
26.6.2000	96	1.00	Cash	100

None of Rekavista Sarawak's shares as tabulated above were issued at a discount, on special terms or instalment payment terms. As at the LPD, there are no outstanding warrants, options, convertible securities or uncalled capital of Rekavista Sarawak.

(e) Subsidiary and Associated Company

As at the LPD, Rekavista Sarawak does not have any subsidiary or associated company.

[THE REST OF THIS PAGE IS INTENTIONALLY LEFT BLANK]

4. INFORMATION ON OUR GROUP (Cont'd)

4.2 LISTING SCHEME

In conjunction with, and as an integral part of the listing of and quotation for our entire enlarged issued and paid-up share capital on the Main Market of Bursa Securities, our Company undertook a Listing Scheme, which involved the following:-

4.2.1 Subdivision

We undertook a subdivision of 100 ordinary shares of RM1.00 each into 400 new ordinary shares of RM0.25 each in our Company on the basis of four (4) new Shares for every one (1) existing ordinary share of RM1.00 each held.

The Subdivision resulted in the issued and paid-up share capital of our Company being increased from 100 ordinary shares of RM1.00 each to 400 Shares.

The Subdivision was completed on 7 May 2015.

4.2.2 Acquisitions

(a) Acquisition of Ikhmas Jaya

We had entered into a conditional share sale agreement dated 17 June 2014 and a supplemental share sale agreement dated 29 August 2014 with the Vendors to acquire the entire issued and paid-up share capital of Ikhmas Jaya comprising 30,000,000 ordinary shares of RM1.00 each for a purchase consideration of RM98,499,900 satisfied wholly by the issuance of 393,999,600 Ikhmas Berhad Shares at an issue price of RM0.25 per Ikhmas Berhad Share. The purchase consideration of Ikhmas Jaya was based on the adjusted proforma consolidated NTA of Ikhmas Jaya (comprising Ikhmas Jaya, Rekavista, IJ Geotechnic and Rekavista Sarawak) as at 31 December 2013 after taking into account the dividend payment, provision for real property gain tax and adjustment to the fair value (net of deferred taxation) of the properties of Ikhmas Jaya of RM13,169,076 as set out below:-

	RM
Proforma consolidated NTA of Ikhmas Jaya as at FYE 2013	96,241,241
Payment of dividend-in-specie by transferring the equity interest of Ikhtisas Emas Sdn Bhd	(a) (10,131,181)
Provision for real property gain tax arising from payment of dividend-in-specie	(456,465)
Add: Fair value adjustment to certain properties of the Ikhmas Jaya (net of deferred taxation)	(b) 13,169,076
Adjusted proforma consolidated NTA of Ikhmas Jaya as at FYE 2013	<u>98,822,671</u>

Notes: -

(a) Please refer to Note (2) in Section 8.1.1 of this Prospectus for further details of the payment of dividend-in-specie.

(b) The fair value adjustment arising from the revaluation of the properties of Ikhmas Jaya is as set out below:-

	(A) Market Value* RM	(B) NBV as at 31.12.2013 RM	(C = A - B) Gross Surplus RM	(D) Deferred Taxation RM	(E = C - D) Net Surplus RM	(F) Equity Interest %	(G = E x F) Amount of Surplus RM
Ikhmas Jaya	25,240,000	11,326,160	13,913,840	744,764	13,169,076	100.00	13,169,076

* The revaluation of the properties is based on market value as appraised by the Independent Registered Valuers. Please refer to Sections 4.14.2 and 12 of this Prospectus for further details on valuation of the properties.

4. INFORMATION ON OUR GROUP (Cont'd)

The shareholdings of the Vendors in our Company pursuant to the Acquisition of Ikhmas Jaya are as follows:-

Shareholders	No. of Ordinary Shares of RM1.00 Each Held in Ikhmas Jaya	Equity Interest %	Purchase Consideration RM	No. of Ikhmas Berhad Shares Issued
Dato' Ang Cheng Siong	9,175,000	30.58	30,124,549	120,498,196
Aura Perdana	8,411,000	28.04	27,616,100	110,464,400
Dato' Ir Dr Khoo Ping Sen	7,157,000	23.86	23,498,751	93,995,004
Siew Mun Lout	2,684,000	8.95	8,812,500	35,250,000
Yap Yoon Fatt	1,373,000	4.57	4,508,000	18,032,000
Yap Beng Teck	600,000	2.00	1,970,000	7,880,000
Woo Chee Meng	600,000	2.00	1,970,000	7,880,000
Total	30,000,000	100.00	98,499,900	393,999,600

(b) Acquisition of Ikhmas Equipment

Ikhmas Jaya had entered into a conditional share sale agreement dated 17 June 2014 with Rekavista to acquire 100.0% of the issued and paid-up share capital of Ikhmas Equipment comprising 2 ordinary shares of RM1.00 each for a cash consideration of RM1,480,000. The purchase consideration of Ikhmas Equipment was based on the audited NTA of Ikhmas Equipment as at 31 December 2013 of RM1,482,340 and was satisfied via internally generated funds.

(c) Acquisition of 60% MM2 Building System

We had entered into a conditional share sale agreement dated 17 June 2014 with Ikhmas Jaya to acquire 60.0% of the issued and paid-up share capital of MM2 Building System comprising 240,600 ordinary shares of RM1.00 each for a cash consideration of RM260,000. The purchase consideration of MM2 Building System was based on the 60.0% of the audited NTA of MM2 Building System as at 31 December 2013 of RM263,885 and was satisfied via internally generated funds.

(d) Acquisition of MM2 Builders

MM2 Building System had entered into a conditional share sale agreement dated 17 June 2014 with Rekavista to acquire 100.0% of the issued and paid-up share capital of MM2 Builders comprising 100,000 ordinary shares of RM1.00 each for a cash consideration of RM2. The purchase consideration of MM2 Builders was based on the audited net tangible liabilities of MM2 Builders as at 31 December 2013 of RM125,267 and was satisfied via internally generated funds.

The Acquisition of Ikhmas Jaya resulted in our issued and paid-up share capital being increased from 400 Ikhmas Berhad Shares to 394,000,000 Ikhmas Berhad Shares.

The new Ikhmas Berhad Shares issued pursuant to the Acquisition of Ikhmas Jaya ranked *pari passu* in all respect with our existing Ikhmas Berhad Shares, except that the new Ikhmas Berhad Shares will not be entitled to any dividends, rights, allotment or other distributions declared, made or paid prior to the date of allotment and issuance of the said Ikhmas Berhad Shares.

The Acquisitions were completed on 3 June 2015.

4. INFORMATION ON OUR GROUP (Cont'd)**4.2.3 Transfer**

Following the Subdivision and Acquisitions, the following shareholders transferred their respective Ikhmas Berhad Shares to IJ Holdings, an investment holding company:-

Shareholders	No. of Ikhmas Berhad Shares	%
Dato' Ang Cheng Siong	120,498,400	30.58
Aura Perdana	110,464,400	28.04
Dato' Ir Dr Khoo Ping Sen	93,995,200	23.86
Siew Mun Lout	35,250,000	8.95
Yap Yoon Fatt	18,032,000	4.57
Yap Beng Teck	7,880,000	2.00
Woo Chee Meng	7,880,000	2.00
Total	394,000,000	100.00

The Transfer was completed on 3 June 2015.

Further details of IJ Holdings are disclosed in Section 6.1.2.1 of this Prospectus.

4.2.4 IPO

Subsequently, we are undertaking an IPO, the details of which are set out in Section 2.3 of this Prospectus.

4.2.5 Listing

Upon completion of the abovementioned Subdivision, Acquisitions, Transfer and IPO, we will seek a listing of and quotation for our entire enlarged issued and paid-up share capital of RM130,000,000 comprising 520,000,000 Shares on the Main Market of Bursa Securities.

[THE REST OF THIS PAGE IS INTENTIONALLY LEFT BLANK]

4. INFORMATION ON OUR GROUP (Cont'd)

4.3 OVERVIEW OF OUR GROUP'S BUSINESS MODEL AND OVERALL STRATEGY

Our Group's business model is depicted in the diagram below:-

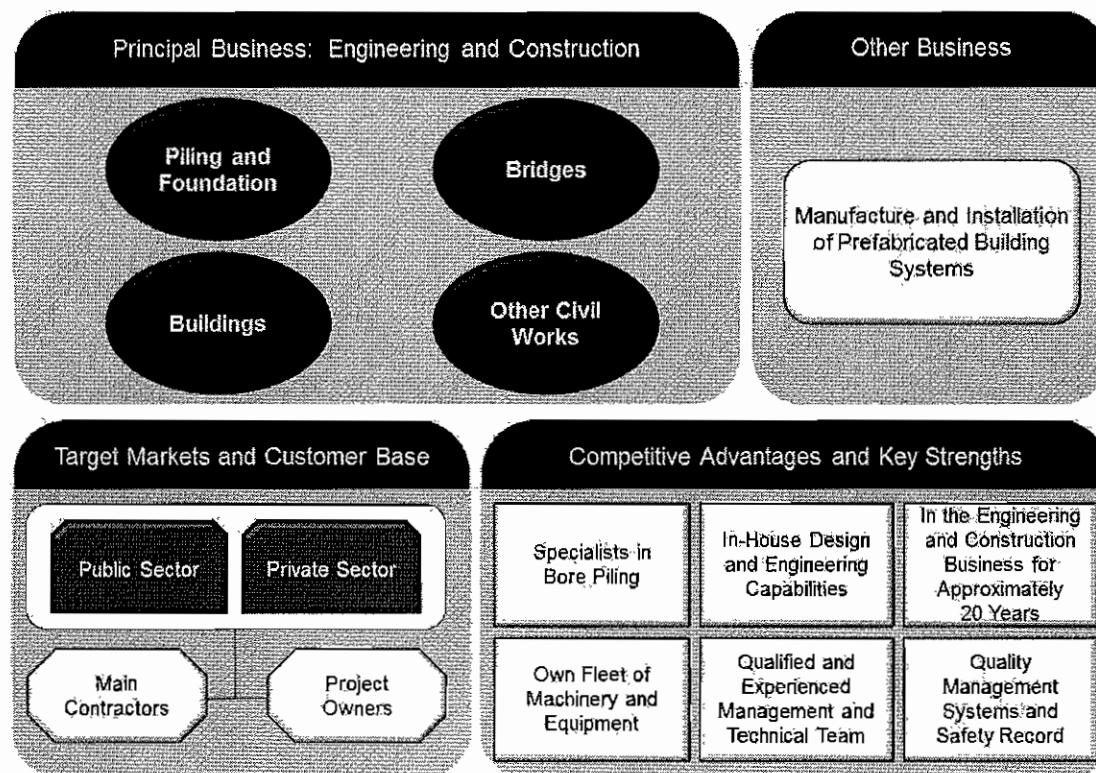

4.3.1 Our Business Activities

Our Group's principal business activities are in engineering and construction, where we are involved in piling and foundation works, bridge construction, building construction and other civil works. Our other business activity is in the manufacture and installation of prefabricated building system. Over the years, we have established ourselves as a bore piling specialist.

Our piling and foundation works, and construction of bridges and buildings are synergistic activities as we commonly undertake piling and foundation works in conjunction with the construction of bridges and buildings. Our other civil works consists of general civil engineering works such as water, gas and sewerage pipe laying works, flood mitigation works and construction of sewerage treatment plant. These other civil works were our Group's initial business activities which provided our Group with the knowledge and experience in general civil engineering works. Currently, our Group do not focus on other civil works. For the FYE 2014, piling and foundation works was our largest revenue contributor, accounting for approximately 54.75% of our Group's total revenue. Construction of bridges and buildings accounted for approximately 42.26% of our Group's total revenue for FYE 2014. There was no revenue contributed from other civil works for FYE 2014.

Our other business activity include the manufacture and installation of prefabricated building system which is a complementary business activity as prefabricated building system is a building construction technology. For FYE 2014, manufacture and installation of prefabricated building system accounted for approximately 2.99% of our Group's total revenue.

4. INFORMATION ON OUR GROUP (Cont'd)

4.3.2 Target Markets and Customer Base

Our target markets include both the private and public sectors for the provision of our products and services. For FYE 2014, private sector projects represented approximately 49.98% of our Group's total revenue while public sector projects represented the remaining of approximately 50.02% of our Group's total revenue. As such, we are able to address the entire spectrum of the market in Malaysia to provide our business with sustainability and growth.

Our customer base comprises main contractors who are primarily responsible for the delivery of the total project, as well as project owners that directly award the relevant package for our work scope.

Revenue from main contractors accounted for approximately 70.06% of our Group's total revenue for the FYE 2014. Our revenue from main contractors was mainly in relation to piling and foundation works. The main contractor of a project is responsible for the total project, which commonly includes piling and foundation works. The main contractor would subcontract the relevant piling and foundation works to us.

4.3.3 Competitive Advantages and Key Strengths

Our competitive advantages and key strengths provide us with the platform to compete against other piling, foundation and construction companies, as well as facilitate business sustenance and future growth.

Our competitive advantages and key strengths are as follows:-

(a) Specialists in Bore Piling

Since our first bore piling project in 2003, we have established ourselves as bore piling specialists with wide experience in various building and infrastructure projects. We have developed strong bore piling technical skills and knowledge through our experience. This enables us to propose alternative design options to our customers, which are sometimes lower in costs without compromising quality and functionality. The ability to propose lower cost solutions has helped us in winning tenders for bore piling works.

Further, since our first bore piling contract in 2003, we have completed bore piling works for a total of 49 building and infrastructure projects with total contract sum of approximately RM823 million. As at the LPD, our ongoing piling and foundation projects which comprised mainly bore piling works amounted to a total contract sum of approximately RM275 million.

We have in-house Engineers that are able to design optimum bore piling systems, taking into consideration factors such as cost effectiveness, practicality, safety, durability and environmental impact. As at the LPD, 30 out of our team of 37 Engineers were focused in the design and construction work for bore piling, headed by our Executive Directors, Siew Mun Lout and Dato' Ir Dr Khoo Ping Sen.

(b) In-House Design and Engineering Capabilities

As an engineering establishment, we have in-house technical professionals including Civil, Structural and Geotechnical Engineers. Our Engineers are involved in the technical design of piling and foundation works, and construction of bridges and buildings.

Since inception, we have undertaken design-and-build contracts for projects involving piling and foundation works, bridges, buildings and sewerage treatment plants. Notably, we were awarded the prestigious IEM Outstanding Engineering Achievement Award in 2014 by the Institution of Engineers Malaysia for our Prai Swing Bridge for the railway electrification and double tracking design-and-build project between Ipoh and Padang Besar. This is a further testament to our in-house design and engineering capabilities.

4. INFORMATION ON OUR GROUP (Cont'd)

We are positioned as a total solutions provider for piling and foundation works, and construction of bridges and buildings. We are capable of proposing design and engineering processes and undertaking responsibilities for the total construction process to meet our customers' requirements. Furthermore, we are also capable of providing alternative designs to our customers. This capability enhances our Group's profile and enables us to tender and secure design-and-build projects.

As at the LPD, we employed a total of 37 qualified Engineers who are involved in our piling and foundation works, and construction of bridges and buildings. .

(c) In the Engineering and Construction Business for Approximately 20 Years

We have been in the engineering and construction business for approximately 20 years and have successfully completed a wide range of projects with total contract sum of approximately RM1.7 billion for both the public and private sectors.

In addition, we have been involved in various high-profile public and private sector projects, such as the Putra Bridge in Putrajaya, Duta-Ulu Kelang Expressway in Kuala Lumpur, railway electrification and double tracking project between Ipoh and Padang Besar at the Malaysia-Thailand border, Storm Water Management and Road Tunnel in Kuala Lumpur, the Klang Valley Mass Rapid Transit Sungai Buloh-Kajang Line in Selangor, Kelana Jaya Light Rail Transit extension in Selangor and KL Eco City in Kuala Lumpur.

Our established track record in the industry can provide confidence to potential customers, which may increase our success rate in securing contracts.

(d) Own Fleet of Machinery and Equipment

We own a diversified fleet of machinery and equipment to support our piling and foundation works, and bridge and building construction. As at the LPD, we own 26 crawler cranes, 18 bore piling hydraulic rigs, 20 excavators, 14 bore pile vibro hammers, 13 mobile cranes, 5 hydraulic breakers, 2 bore pile mechanical rigs, 1 CSM cutter machine and 1 tower crane. Our wide range of machinery and equipment enables us to adopt various construction methods, meet different customers' requirements, as well as ensuring the timely completion of our projects as we do not need to rely on rental of third party machinery and equipment.

Operating our own fleet of machinery and equipment also allows us to differentiate ourselves from other service providers that rely on rented machinery and equipment. We can expediently deploy our own machinery and equipment to various locations as required.

In some situations, operating our own machinery and equipment enable us to be more flexible in pricing to win contracts as our operating costs would be lower compared to contractors that have to rent their machinery and equipment.

For instance, when comparing to new entrants or smaller incumbent operators who do not have their own fleet of machinery and equipment, we are relatively less constrained by the availability of machinery and equipment in the rental market and/or exposed to potential fluctuation in rental rates. As such, we can be more flexible in terms of our tender pricing as well as ensuring the timely deployment of machinery and equipment to our customer's site.

As at the LPD, the NBV of our material machinery and equipment are approximately RM58.65 million.

[THE REST OF THIS PAGE IS INTENTIONALLY LEFT BLANK]

4. INFORMATION ON OUR GROUP (Cont'd)

(e) Qualified and Experienced Management and Technical Team

We have a management team of qualified and experienced personnel to lead and manage our business operations. Our Group Managing Director, Dato' Ang Cheng Siong, has more than 30 years of experience in the building and construction industry, specialising in project management of civil and building works. Our Executive Director, Siew Mun Lout has more than 25 years of construction experience in bridge works, earthworks and roadworks including breakwater constructions. Our Executive Director, Dato' Ir Dr Khoo Ping Sen, has more than 35 years of experience in the building and construction industry, specialising in bore piling and foundation works, as well as structural designs for bridges, high-rise buildings and industrial buildings.

Furthermore, our key management also include qualified technical professionals such as Civil and Structural Engineers, Geotechnical Engineers, Mechanical Engineers, Electrical Engineers, Quantity Surveyors and Project Managers. As at the LPD, we have 37 qualified Engineers on our payroll. In addition, our projects are led by experienced project managers, some of whom have more than 25 years of project management experience.

Our management and technical team of qualified and experienced personnel will provide our Group with a sustainable and stable platform for continuing business growth.

(f) Quality Management Systems and Safety Track Record

We continuously emphasise maintaining quality standards in undertaking all of our construction projects. This is reflected by our commitment in complying to the ISO 9001:2008 Quality Management System for the provision of civil engineering, project management and building construction services, including construction of bridges, dams and reservoirs, pipe laying, water treatment plants, flood mitigation works, oil and gas works and foundation works. Our ISO certification provides customers with assurance and confidence that our services adhere to recognised quality standards and processes.

In addition, we have been recognised for our adherence to work place safety standards, as demonstrated by the following awards:-

- (i) 500 thousand man-hours without lost time injury - Certificate of Appreciation by Pembinaan KS Tebrau Sdn Bhd;
- (ii) Good management on safety, health and environment at the workplace and contribution to the reduction of work related injury and disease – Certificate of Appreciation by MMC-Gamuda Joint Venture for the railway electrification and double tracking project – Ipoh to Padang Besar;
- (iii) 2 million hours working without lost time injury – Certificate of Appreciation by MMC-Gamuda Joint Venture for the railway electrification and double tracking project – Ipoh to Padang Besar; and
- (iv) 2.6 million man-hours without lost time injury at Package V8 of the Klang Valley Mass Rapid Transit Sungai Buloh-Kajang Line project from 1 January 2013 to 31 December 2013 by UEM Construction Sdn Bhd.

Our work place safety track record provides our customers with assurance that their projects will not be disrupted by work place accidents. More importantly, it demonstrates that we value our workers' well-being and ensure a safe working environment.

4. INFORMATION ON OUR GROUP (Cont'd)

4.4 AWARDS, RECOGNITION AND AFFILIATIONS

4.4.1 Awards and Recognition

Year	Awards and Recognition
2006	Winner of Outstanding SMEs Category ⁽¹⁾ of the Golden Bull Award 2006
2007	Second Runner Up for implementing the "Best Environmental Management System" by Putrajaya Holdings Sdn Bhd
2008	Winner of Outstanding SMEs Category ⁽¹⁾ of the Golden Bull Award 2008
2009	Winner of Outstanding SMEs Category ⁽¹⁾ of the Golden Bull Award 2009
2010	Ranked 5 th Position in the Super Golden Bull Category ⁽²⁾ of the Golden Bull Award 2010 2 million hours working without lost time injury – Certificate of Appreciation by MMC-Gamuda Joint Venture for the railway electrification and double tracking project from Ipoh to Padang Besar
2011	Ranked 1 st in the Super Golden Bull Category ⁽²⁾ of the Golden Bull Award 2011 500 thousand man-hours without lost time injury - Certificate of Appreciation by Pembinaan KS Tebrau Sdn Bhd Good management on safety, health and environment in the workplace and contribution to the reduction of work related injury and disease -- Certificate of Appreciation by MMC-Gamuda Joint Venture for the railway electrification and double tracking project from Ipoh to Padang Besar
2013	OSH Management - Bore Pile Specialist Year 2013 - Certificate of Attendance by the Malaysian Occupational Safety & Health Professional's Association (MOSHPA)
2014	IEM Outstanding Engineering Achievement Award for the design and construction of the Prai Swing Bridge for the railway electrification and double tracking project between Ipoh and Padang Besar by the Institution of Engineers Malaysia 2.6 million man-hours without lost time injury at Package V8 of the Klang Valley Mass Rapid Transit Sungai Buloh-Kajang Line project from 1 January 2013 to 31 December 2013 by UEM Construction Sdn Bhd

Notes:-

- (1) The Outstanding SMEs Category is for SMEs with annual sales turnover of RM5 million and above up to RM75 million in the last three (3) financial years. One hundred (100) companies are selected as winners for this category based on a number of criteria including operational and financial performances, growth plans, market presence and innovation.
- (2) The Super Golden Bull Category is for SMEs with annual sales turnover of RM75 million and above up to RM150 million in the last three (3) financial years and not more than 150 full-time employees. Ten (10) companies are selected as the winners for this category based on a number of criteria including operational and financial performances, growth plans, market presence and innovation.

[THE REST OF THIS PAGE IS INTENTIONALLY LEFT BLANK]

4. INFORMATION ON OUR GROUP (Cont'd)

4.4.2 Enterprise and Trade Affiliations

Our Company, through our subsidiary, is a member of the following association:-

Company	Membership Organisation	Membership Number	Member Since (Year)
Ikhmas Jaya	Master Builders Association Malaysia	0596/06	2006

4.5 OVERVIEW OF OUR GROUP'S BUSINESS ACTIVITIES

(a) Principal Business

Our principal business activities are in engineering and construction, where we are involved in piling and foundation works, bridge construction, building construction and other civil works.

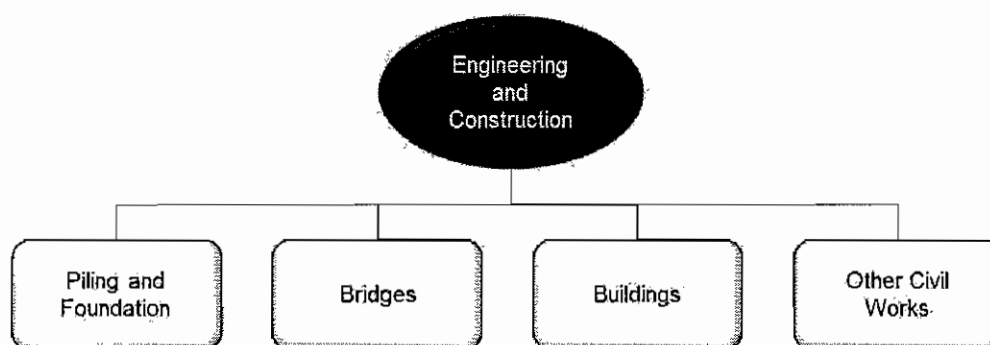

As an engineering company we have in-house technical professionals such as Civil, Structural and Geotechnical Engineers. Our Engineers are involved in the technical design and specifications for piling and foundation works, and construction of bridges and buildings. As for other civil works, depending on the nature of the project, we may require our in-house engineering expertise.

Having our own in-house engineering expertise is crucial as it enables us to provide total solutions for piling and foundation works, as well as for construction of bridges and buildings. This is a key advantage over other construction companies that do not have in-house design and technical capabilities. Such companies have to engage third party Engineers, which can be inconvenient for the project owners or main contractors.

As a construction company, we undertake all of our own construction works. We use a combination of in-house and subcontracted labour for our construction activities. We also own and operate our own fleet of machinery and equipment, thus enabling us to complete projects in a timely manner as we do not need to rely on rental of third party machinery and equipment.

Our subsidiaries, Ikhmas Jaya and Rekavista, are registered with the CIDB as Grade 7 contractors mainly for civil engineering construction and building construction specialisations. As a Grade 7 contractor, we are able to undertake projects with unlimited tender capacity. Please refer to Sections 4.15(a) and 4.15(c) for more details on the specific categories registered by Ikhmas Jaya and Rekavista with the CIDB respectively.

As at the LPD, our ongoing projects comprising piling and foundation, as well as construction of bridges and buildings amounted to a total contract sum of approximately RM659.93 million as disclosed in Sections 4.5.1.5, 4.5.2.2 and 4.5.3.3 of this Prospectus. As at the LPD, we did not have any ongoing projects for other civil works.

4. INFORMATION ON OUR GROUP (Cont'd)

(b) Others

Our other business activity include the manufacture and installation of prefabricated building system which is a complementary business activity as prefabricated building system is a building construction technology.

As at the LPD, we are undertaking two (2) ongoing prefabricated building system projects with a total contract sum amounting to approximately RM60.66 million as disclosed in Section 4.5.4.2 of this Prospectus.

(c) Business Synergies

Our various business activities are highly synergistic.

The core of our business is our piling and foundation works. Piling and foundation works are also required when constructing bridges and buildings. As such, these three (3) activities are highly synergistic in terms of activities as well as from our customers' perspective. Our ability to carry out these synergistic business activities enable us to provide total solutions to our customers, where we are able to construct substructures comprising piling and foundation as well as superstructures such as bridges and buildings.

Our other business activity is in the manufacture and installation of prefabricated building system. Our prefabricated building system is a building construction method that utilises prefabricated modules manufactured in our factory that are brought on-site for installation and completion.

(d) Revenue Segmentation

Our revenue segmentation by business activities for FYE 2014 is as follows:-

Revenue by Business Activities ⁽¹⁾	RM '000	%
Piling and Foundation	160,676	54.75
- Buildings	109,525	37.32
- Infrastructures	51,151	17.43
Bridge Construction ⁽²⁾	74,579	25.41
Building Construction ⁽²⁾	49,467	16.85
Manufacture and Installation of Prefabricated Building System	8,783	2.99
Total	293,505	100.00

Notes:-

(1) There was no revenue derived from other civil works for FYE 2014.

(2) These are for total solution and include all necessary piling and foundation work where relevant.

For FYE 2014, our Group's total revenue amounted to approximately RM293.51 million.

Piling and foundation represented the largest proportion of our Group's total revenue at approximately 54.75% for FYE 2014. We undertook piling and foundation works for buildings and infrastructure, which accounted for approximately 37.32% and 17.43% of our Group's total revenue for the FYE 2014 respectively.

This was followed by the construction of bridges and buildings, which accounted for approximately 25.41% and 16.85% of our Group's total revenue for the FYE 2014 respectively.

The remaining of approximately 2.99% of our Group's total revenue for FYE 2014 was derived from the manufacture and installation of prefabricated building system.

4. INFORMATION ON OUR GROUP (Cont'd)

For FYE 2014, all of our revenue was derived from Malaysia. The breakdown of our Group's total revenue for FYE 2014 by states was as follows:-

Revenue by Location	RM'000	%
Kuala Lumpur	153,673	52.36
Selangor	113,966	38.83
Putrajaya	11,332	3.86
Terengganu	8,516	2.90
Penang	3,968	1.35
Pahang	1,228	0.42
Perak	471	0.16
Melaka	351	0.12
Total	293,505	100.00

For FYE 2014, the large majority of our revenue was derived from Kuala Lumpur, Selangor and Putrajaya, which accounted for a combined total of approximately 95.05% of our Group's total revenue. The proximity of these three (3) areas enables us to deploy our professional staff, on-site workers and machinery and equipment efficiently. This also enables us to minimise the cost of transporting our machinery and equipment among the various construction sites, as well as minimise travel and related time, and costs for personnel.

Our business focus in Kuala Lumpur, Selangor and Putrajaya allows us to address a relatively large market. This is supported by the fact that in 2014, the total value of construction work done in Kuala Lumpur, Selangor, Putrajaya and Labuan amounted to RM42.48 billion, representing 41.42% of the total for Malaysia (*Source: Independent Assessment of the Piling, Foundation and Construction Industry for Infrastructure and Buildings in Malaysia prepared by Vital Factor*).

[THE REST OF THIS PAGE IS INTENTIONALLY LEFT BLANK]

4. INFORMATION ON OUR GROUP (Cont'd)

4.5.1 Piling and Foundation

Piling and foundation works is our key business activity which contributed approximately RM160.68 million or 54.75% of our Group's total revenue for FYE 2014.

Our piling and foundation works are focused in the following areas:-

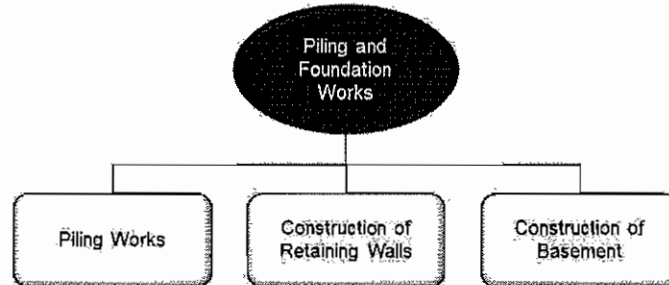

4.5.1.1 Piling Works

Piling work is the process of placing piles or supporting columns below the ground to support or to serve as the foundation for above ground structures. Piles are made of materials such as wood, steel, reinforced concrete, pre-stressed concrete and composites (piles made from a combination of different materials). Most of the piles used today are made of concrete, especially those used for large structures and high-rise buildings. Piles commonly sit above rock formation or some other hard layer of natural or man-made material. The pile's function is to support the above ground structure by transferring its load down to the rock formation or hard layer of material.

(a) Bore Piling

We specialise in bore piling. Bored piles are mainly used to support high-rise buildings and large structures. Bored piles are constructed in situ, in that it is constructed at the specific spot where the piles are required to be placed.

Bored piles are formed by boring or excavating a hole into the soil to the required depth. A reinforcement cage made of steel bars is then lowered into the hole and wet concrete is poured in and left to set.

The majority of our piling and foundation works involve bore piling. Since we undertook our first bore piling project in 2003, we have undertaken many types of piling works for a wide range of projects for buildings and infrastructure.

With our wide experience and track record, we have since established ourselves as specialists in bore piling and foundation works.

- Step 1:** A vertical hole is bored to the required depth
- Step 2:** A skeletal metal reinforcement cage is lowered down the bored hole
- Step 3:** Concrete is poured down the hole and allowed to set

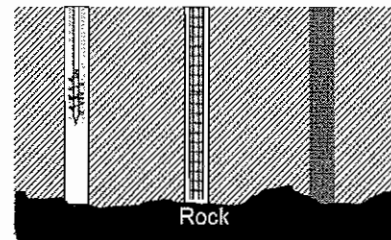

In situ construction of bored pile in Kajang for Package V8 of the Klang Valley Mass Rapid Transit Sungai Buloh-Kajang Line project undertaken by our Group

4. INFORMATION ON OUR GROUP (Cont'd)

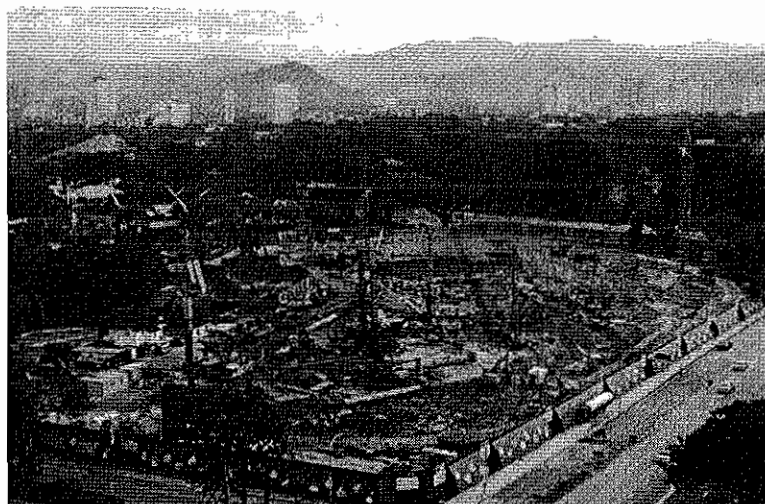

Our Group's first bore piling project, undertaken for Prince Court Medical Centre, a private hospital located on Jalan Tun Razak, Kuala Lumpur

(b) Micropiling

Micropile is a small pile generally with diameter of less than 300 mm. It is cast in situ using the same process as bored piles. Micropiles have smaller bearing capacity compared to bored piles. Micropiles are typically used to strengthen the foundation of an existing building or structure. Due to the smaller size of the machine used, micropiles are also frequently used at sites that are difficult to access.

We have also undertaken micropiling jobs as part of our full portfolio of piling solutions.

(c) Other Piling Methods

We strive to provide total piling solutions to our customers who are main contractors and project owners. In some cases, there are projects that require other piling methods that are suitable for a particular application. We are a bore piling specialist and as such, we outsource certain other types of piling works such as driven piling and jack-in piling to third party piling contractors. This is because specialised machinery is required to perform these types of piling.

4.5.1.2 Construction of Retaining Walls

Retaining walls are structures used to retain soil, rock or other materials in a vertical condition. As such, they provide a lateral support to vertical slopes of soil that would otherwise collapse. They are used in a wide variety of civil engineering applications including embankment stabilisation and the construction of basement walls, underpasses or tunnel approaches, in-ground tanks and other buried structures.

[THE REST OF THIS PAGE IS INTENTIONALLY LEFT BLANK]

4. INFORMATION ON OUR GROUP (Cont'd)

We mainly construct retaining walls utilising the following retaining wall systems:-

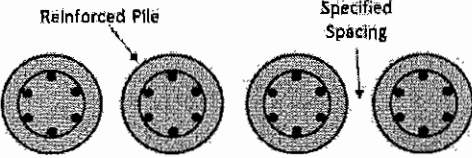
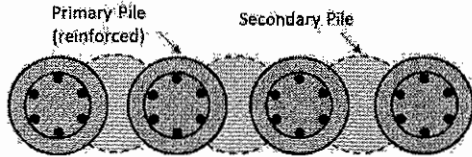
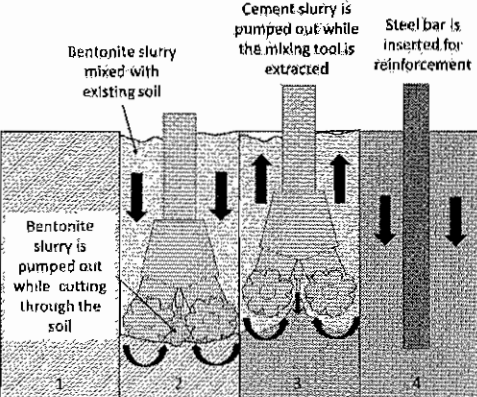
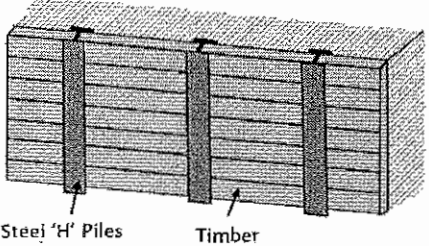
Type	Description
<p>Contiguous Bored Pile Wall (top view)</p> 	<p>A contiguous bored pile wall is constructed using closely-spaced bored piles. The bored piles may be virtually touching each other or are separated by specified spacing.</p>
<p>Secant Pile Wall (top view)</p> 	<p>A secant pile wall is constructed using intersected bored piles where primary piles (which are usually reinforced) are installed first. Once the primary piles gain sufficient strength, the secondary piles are constructed in between the primary.</p>
<p>CSM Wall (cross-sectional view)</p> 	<p>A CSM wall is similar to a diaphragm wall, except that it is constructed using CSM technology. With CSM technology, a cement slurry is mixed with existing soil in situ and allowed to harden. The process utilises two sets of cutting wheels that cut the surrounding soil while simultaneously blend injected cement slurry with the existing soil. This results in the formation of hardened rectangular panels once the cement hardens.</p>
<p>Soldier Pile Wall</p> 	<p>A soldier pile wall is constructed using vertical steel piles with horizontal lagging (timber sheeting).</p>

[THE REST OF THIS PAGE IS INTENTIONALLY LEFT BLANK]

4. INFORMATION ON OUR GROUP (Cont'd)

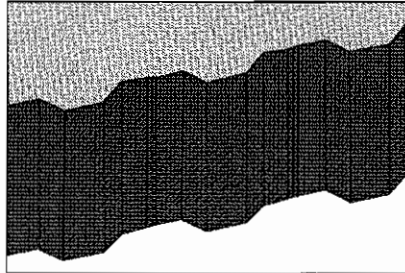
Type	Description
Steel Sheet Pile Wall 	A steel sheet pile wall is constructed by driving steel sheet piles vertically into the ground to support lateral pressure.

We are able to design and construct a wide range of retaining walls, including contiguous bored pile wall, secant pile wall, CSM wall, soldier pile wall and steel sheet pile walls.

4.5.1.3 Construction of Basements

Basement construction is sometimes incorporated as part of piling and foundation works as it requires excavating soil to various depths and constructing retaining walls to prevent the surrounding soil from collapsing into the excavated area.

Once the retaining walls are constructed, there are two (2) methods that can be employed to construct the basement:-

- (a) **Bottom-up** method where soil is excavated to create a cavity for the construction of the basement.
- (b) **Top-down** method where the ground floor level is constructed first. Thereafter, soil is excavated below the ground floor level to create a cavity to construct the next level down. This process continues until it reaches the desired depth. This approach allows above ground and below ground structures to be constructed concurrently, which can greatly reduce construction time.



Basement works using the bottom-up method for Parcel C of the KL Eco City Project at Jalan Bangsar, Kuala Lumpur as undertaken by our Group

4. INFORMATION ON OUR GROUP (Cont'd)

4.5.1.4 Completed Piling and Foundation Projects

For the past five (5) financial years and up to the LPD, our completed piling and foundation projects with contract sum exceeding RM1.0 million are as follows:-

No.	Project Name	Scope of Work	Customers	⁽¹⁾ Total Contract Value (RM'000)	Project Start Date	⁽²⁾ Project Completion Date
1.	Paradigm Mall, Kelana Jaya	Piling works	WCT Construction Sdn Bhd	52,800	April 2008	November 2011
2.	Railway electrification and double tracking - Package N2	Bore piling and ancillary works	MMC-Gamuda Joint Venture	8,336	October 2008	October 2013
3.	Railway electrification and double tracking - Package N1	Bore piling and ancillary works	MMC-Gamuda Joint Venture	6,153	May 2009	October 2013
4.	JB-Nusajaya Highway - Section 2: CH 2400 to CH 9500	Bore piling works	Segi Tiara Sdn Bhd	4,506	June 2009	September 2010
5.	Institusi Perguruan Bahasa Melayu Malaysia	Bore piling works	Tidal Marine Engineering Sdn Bhd	6,337	December 2009	March 2010
6.	Bandar Sri Damansara serviced apartment	Site clearance, earthworks, bore piling, pile cap and ancillary works	Biaxis (M) Sdn Bhd	6,261	December 2010	August 2011
7.	5000-T/D Clinker Production Plant, Gopeng	Piling works	Tian Jin Cement Industry Engineering (M) Sdn Bhd	28,287	January 2011	December 2012
8.	Railway electrification and double tracking - Package N4, Sub-package S15	Contiguous bored pile wall and ancillary works	MMC-Gamuda Joint Venture	5,488	February 2011	February 2012
9.	Kelana Jaya Line Light Rail Transit Extension - Package 1A and 1B	Bore piling works	Trans Resources Corporation Sdn Bhd	29,701	March 2011	⁽³⁾ April 2014
10.	Putrajaya Tabung Haji Office Complex (Precinct 3)	Piling and substructure works	Econpile (M) Sdn Bhd	40,149	September 2011	February 2013
11.	NSCI Bahau Second Clinker Production Line of 5000TPD	Bore piling works	SEC (Malaysia) Contracting Sdn Bhd	18,495	November 2011	September 2012
12.	Damai 88, Ampang	Piling and substructure works	D.J. Design & Suppliers Sdn Bhd	36,066	March 2012	March 2013
13.	DA:Men, USJ	Bore piling works	Domain Resources Sdn Bhd	19,000	May 2012	⁽³⁾ June 2013

4. INFORMATION ON OUR GROUP (Cont'd)

No.	Project Name	Scope of Work	Customers	⁽¹⁾ Total Contract Value (RM'000)	Project Start Date	⁽²⁾ Project Completion Date
14.	Parcel C of the KL Eco City	Contiguous bored pile wall, earthworks, piling and basement structure works	Setia Precast Sdn Bhd	163,360	June 2012	May 2014
15.	Elevated Station Package S7 at Balakong and Taman Koperasi	Bore piling works	Apex Communications Sdn Bhd	1,349	April 2013	⁽³⁾ April 2014
16.	Bukit Tunku Bungalow – Package 1	Earthworks and piling works	An individual	6,721	April 2013	March 2015
17.	Elevated Station Package S3 at The Curve, One Utama and Taman Tun Dr. Ismail	Bore piling and pile cap works	UEM Construction Sdn Bhd	3,589	April 2013	⁽³⁾ May 2015
18.	Bukit Jalil commercial development	Piling and pile cap construction	Ho Hup Construction Company Berhad	12,177	September 2013	September 2014
19.	Putrajaya (Precinct 16) Civil Servant High-Rise Apartments	Substructure works	Apex Communications Sdn Bhd	11,594	March 2014	January 2015
20.	9 Seputeh mixed development	Piling works	Gelanggang Harapan Construction Sdn Bhd	19,000	June 2014	December 2014

Notes:-

- (1) Total contract value includes variations orders.
- (2) Based on issuance of the CPC.
- (3) Physical construction completed but pending issuance of CPC.

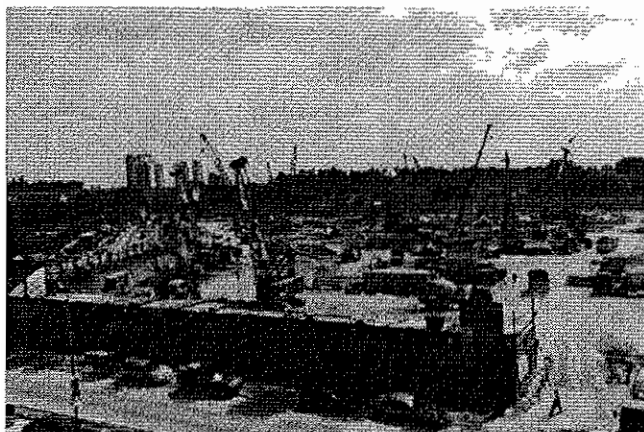

Bore piling works for DA:Men, a mixed development located at USJ, Selangor as undertaken by our Group



Piling works for Paradigm Mall, a mixed development located at Kelana Jaya, Selangor as undertaken by our Group

4. INFORMATION ON OUR GROUP (Cont'd)

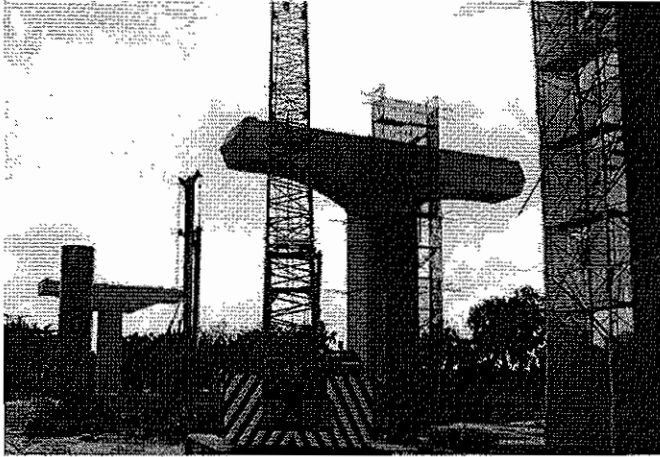

Bore piling works for the Kelana Jaya Line Light Rail Transit Extension Project – Package 1A and 1B as undertaken by our Group

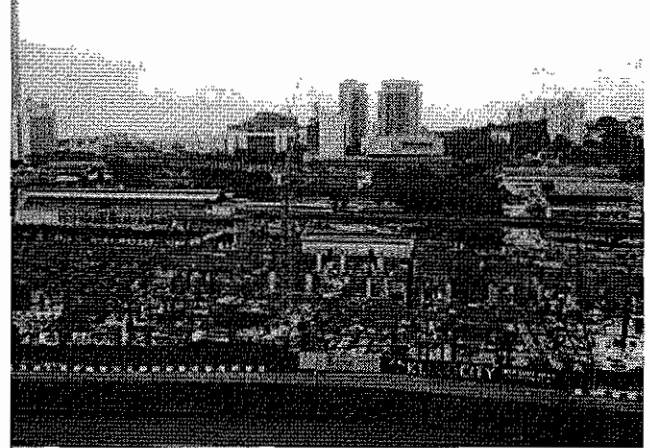

Contiguous bored pile wall, earthworks, piling and basement structure works for Parcel C of the KL Eco City project as undertaken by our Group

4.5.1.5 Ongoing Piling and Foundation Projects

As at the LPD, our ongoing piling and foundation projects amounted to a total contract sum of approximately RM274.88 million. Details are as follows:-

No.	Project Name	Scope of Work	Customers	#Total Contract Value (RM'000)	Project Start Date	Expected Completion Date	Approximate Percentage of Completion as at LPD
1.	Parcel D of the KL Eco City	Substructure works and elevated roadway	KL Eco City Sdn Bhd	108,743	December 2012	May 2016	67%
2.	Package V8 of the Klang Valley Mass Rapid Transit Sungai Buloh-Kajang Line	Bore piling, caisson piles and micropiles works	UEM Construction Sdn Bhd	98,173	December 2012	June 2015	92%
3.	Duta-Ulu Kelang Expressway 2 (Section 2 – Tun Razak Link) at Mainline MC30	Bore piling works	Pembinaan Hamid Abdul Rahman Sdn Bhd	18,500	February 2014	August 2015	47%
4.	Duta-Ulu Kelang Expressway 2 (Section 1 – Sri Damansara Link) at Mainline ML1	Bore piling works	Pembinaan Sahabatjaya Sdn Bhd	16,460	April 2014	August 2015	54%
5.	Sri Kuala Lumpur School (Sri KL)	Substructure works	Othman Merican Educational Development Berhad	8,700	June 2014	June 2015	90%

4. INFORMATION ON OUR GROUP (Cont'd)

No.	Project Name	Scope of Work	Customers	#Total Contract Value (RM'000)	Project Start Date	Expected Completion Date	Approximate Percentage of Completion as at LPD
6.	9 Seputeh mixed development	Contiguous bored piles	Gelanggang Harapan Construction Sdn Bhd	1,500	April 2015	August 2015	30%
7.	Ampang Line Light Rail Transit – Sentul Timur Extension project	Bore piling works	MRCB Engineering Sdn Bhd	2,727	May 2015	July 2015	1%
8.	Light Rail Transit Kelana Jaya Station 2	Bore piling works	Trans Resources Corporation Sdn Bhd	14,990	May 2015	September 2015	8%
9.	Duta-Ulu Kelang Expressway 2 (Section 2 – Tun Razak Link) at Ramp MCT0	Contiguous bored piles	Pembinaan Hamid Abdul Rahman Sdn Bhd	5,083	May 2015	November 2015	1%
Total				274,876			

Note:-

Total contract value includes variations orders.

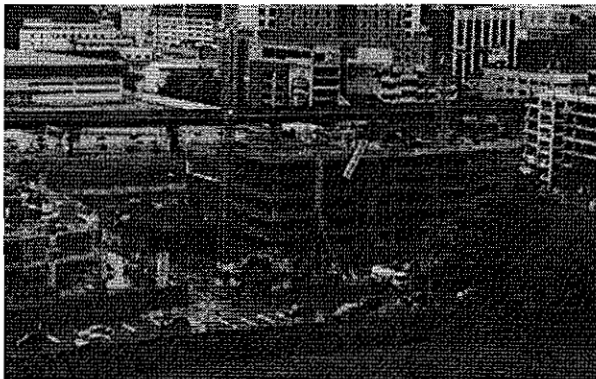

Substructure works of a 7-storey car park and elevated roadway for Parcel D of the KL Eco City project as undertaken by our Group

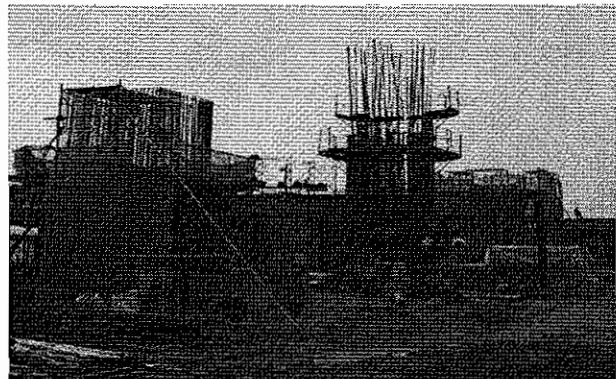

Bore piling, caisson piles and micropile works for Package V8 of the Klang Valley Mass Rapid Transit Sungai Buloh – Kajang Line project as undertaken by our Group

4.5.2 Construction of Bridges

We are involved in construction of bridges, which contributed approximately RM74.58 million or 25.41% of our Group's total revenue for FYE 2014.

A bridge is a structure spanning an obstacle such as a body of water, valley or road for the purpose of providing a route over the obstacle. Bridges can carry a number of different transportation systems including roads, railways, canals, pipelines and footpaths.

The physical structure of a bridge is divided into two parts:-

4. INFORMATION ON OUR GROUP (Cont'd)

- (a) Superstructure consists of the bridge deck (roadway/ railway), structural members and others such as railing, lighting, footpath and drainage; and
- (b) Substructure, also known as foundation, consisting of abutments or end-bents, piers or interior bents, footings and piling.

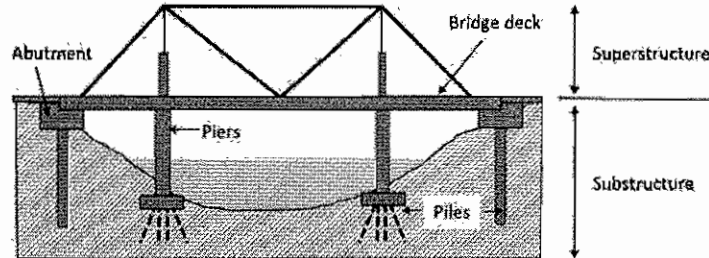

The materials used to build bridge structures include timber, stone, steel and more recently reinforced and pre-stressed concrete. Modern bridges are currently built using concrete, steel, fibre reinforced polymers, stainless steel or composites (combination of different types of materials).

There are various designs where it serves different purposes and are applied to different situations. Design of bridges varies depending on the function of the bridge, the material used, the nature of the terrain where the bridge is constructed and anchored as well as the funds available to construct it.

Generally, there are fixed and movable bridges. Fixed bridges are set into place. Movable bridges are able to change their positions to accommodate traffic below them, usually ships and barges. Movable bridges are commonly constructed on navigable waters as it is usually not feasible to construct tall bridges with high clearance for vessels to pass through.

Furthermore, a movable bridge solution ensures that the bridge is not built with a steep incline that is impassable to rail and other traffic. However, the disadvantage of movable bridges is that traffic on the bridge must be halted when it is opened to allow ships to pass through. The three (3) most common movable bridge types are bascule bridge, swing bridge and lift bridge. Since our Group commenced operations we have constructed a swing bridge.

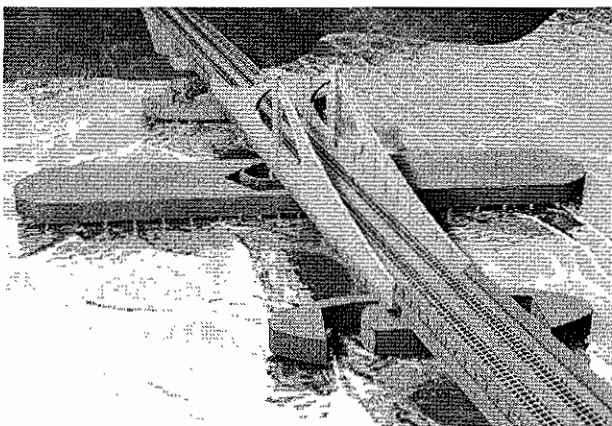

Artist's impression of the Prai Swing Bridge constructed by our Group (Bridge Closed)

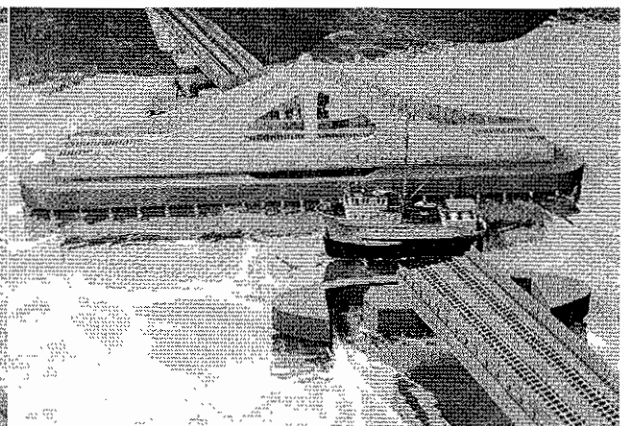

Artist's impression of the Prai Swing Bridge constructed by our Group (Bridge Open)

4. INFORMATION ON OUR GROUP (Cont'd)

We mainly construct bridges based on the following types of bridge designs:-

- (i) Beam bridge as disclosed in Section 4.9.3(a) of this Prospectus;
- (ii) Girder bridge as disclosed in Section 4.9.3(b) of this Prospectus;
- (iii) Truss bridge as disclosed in Section 4.9.3(c) of this Prospectus;
- (iv) Arch bridge as disclosed in Section 4.9.3(d) of this Prospectus; and
- (v) Swing bridge as disclosed in Section 4.9.3(e) of this Prospectus.

4.5.2.1 Completed Projects

For the past five (5) financial years and up to the LPD, our completed bridge construction projects with contract sum exceeding RM1.0 million are detailed as follows:-

No.	Project Name	Scope of Work	Customers	⁽¹⁾ Total Contract Value (RM'000)	Project Start Date	⁽²⁾ Project Completion Date
1.	JB-Nusajaya Highway - Section 2: CH 2400 to CH 9500	Infrastructure works, ground improvement, bridge structures, drainages, road works, landscape and associated works	Segi Tiara Sdn Bhd	48,601	July 2009	June 2011
2.	Railway electrification and double tracking- Prai Swing Bridge	Design and construction of the Prai Swing Bridge and associated works	MMC-Gamuda Joint Venture	80,478	February 2010	July 2013

Notes:-

- (1) Total contract value includes variations orders.
- (2) Based on issuance of the CPC.

[THE REST OF THIS PAGE IS INTENTIONALLY LEFT BLANK]

4. INFORMATION ON OUR GROUP (Cont'd)

4.5.2.2 Ongoing Projects

As at the LPD, our ongoing bridge construction project has a total contract sum of approximately RM274.35 million. Details are as follows:-

No.	Project Name	Scope of work	Customer	#Total Contract Value (RM'000)	Project Start Date	Expected Completion Date	Approximate Percentage of Completion as at LPD
1.	Subang-Skypark Terminal Railway Track – Phase 1	Infrastructure works	Konsortium Skypark Link Sdn Bhd – Lion Pacific Sdn Bhd	269,800	November 2013	November 2015	48%
2.	Pier 488 & 489 for the Ampang Line Light Rail Transit	Infrastructure works	MRCB Engineering Sdn Bhd	4,550	April 2015	July 2015	35%
Total				274,350			

Note:-

Total contract value includes variations orders.

4.5.3 Construction of Buildings

We are involved in construction of buildings which contributed approximately RM49.47 million or 16.85% of our Group's total revenue for FYE 2014.

4.5.3.1 Building Construction Works

Construction of buildings is focused on physical buildings commonly used by people, such as residential, commercial, industrial, leisure and institutional buildings. Some of the types of buildings are as follows:-

- (a) Residential buildings including terraced houses, semi-detached houses, detached houses, flats, apartments and condominiums;
- (b) Commercial buildings including shop units, offices and shopping complexes;
- (c) Industrial buildings including factories and warehouses;
- (d) Leisure buildings including hotels, motels, serviced apartments, resorts and clubs;
- (e) Institutional buildings including hospitals, educational institutions and police barracks; and
- (f) Public amenity buildings including railway stations, sports stadium, museums and community centres.

[THE REST OF THIS PAGE IS INTENTIONALLY LEFT BLANK]

4. INFORMATION ON OUR GROUP (Cont'd)

For construction of buildings, we are typically engaged directly by the project owner as the main contractor of the project. We will mainly undertake superstructure works, while subcontracting out portions of work that are not cost effective for us to carry out in-house.

Our Group undertakes a wide range of activities for the construction of buildings, which may include, amongst others, the following:-

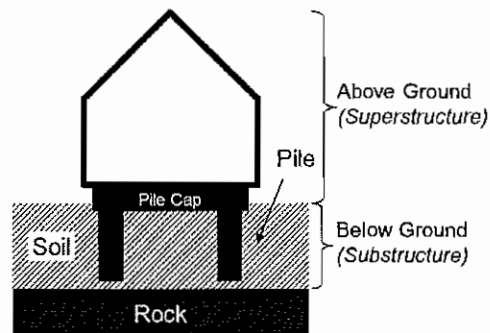

- (i) Overall project planning and management;
- (ii) On-site preparation activities prior to site alteration such as surveying, clearing of vegetation, placement of stakes and flagging guides, and movements of machine and equipment;
- (iii) Construction of access roads which may entail clearing and grubbing, sub-grade stabilisation, base course construction and paving;
- (iv) Establishment of construction staging area such as for heavy equipment to be delivered to the site, fuelled, maintained and stored in temporary facilities when they are not in use;
- (v) Procurement and arrangement for material storage such as soil, rocks and other building materials that must be hauled and stored at the site;
- (vi) Site preparation such as removal of surface vegetation and major root systems, and also discharge of water for concrete washout, pumping for work area isolation and washing vehicles;
- (vii) Earthworks such as grading, excavating, backfilling and compaction, base course, soil stabilisation, slope protection and soil treatment;
- (viii) Site restoration and clean-up such as protection of bare earth by seeding, planting, mulching and fertilising;
- (ix) Foundation works such as piling and caissons installation;
- (x) Sewage and drainage;
- (xi) Water reticulation works;
- (xii) Erection of buildings and structures;
- (xiii) Mechanical and electrical works;
- (xiv) Paving such as walkways, roads and parking areas, curbs, and surfacing; and
- (xv) Landscaping.

[THE REST OF THIS PAGE IS INTENTIONALLY LEFT BLANK]

4. INFORMATION ON OUR GROUP (Cont'd)



Construction of a police training centre in Terengganu undertaken by our Group

Since we commenced operations, we have undertaken the construction of the following types of buildings:-

Category	Type of Buildings
Residential	Flats/ Apartments/ Condominium
	Serviced apartments
Commercial	Shop units
Institutional	Educational institutions
	Police training centre
Others	Hangar
	Control building

4.5.3.2 Completed Projects

For the past five (5) financial years and up to the LPD, our completed projects in construction of buildings are detailed as follows:-

No.	Project Name	Scope of Work	Customers	⁽¹⁾ Total Contract Value (RM'000)	Project Start Date	⁽²⁾ Project Completion Date
1.	KT Prima Business Centre, Terengganu	Building works	Ikhtisas Emas Sdn Bhd	16,526	November 2008	July 2012
2.	Police training centre (PULAPOL), Terengganu	Design-and-build building constructions	Denrich-Naluri Rezeki JV	112,162	April 2009	October 2013
3.	Hangar on Jalan Lapangan Terbang Subang, Selangor	Building works	Airod Sdn Bhd	39,920	July 2011	March 2013
4.	Railway electrification and double tracking- Package N5, Sub-Package S16	Building works for control building and other ancillary works	MMC-Gamuda Joint Venture	1,896	December 2010	November 2014

4. INFORMATION ON OUR GROUP (Cont'd)

Notes:-

- (1) Total contract value includes variations orders.
- (2) Based on issuance of the CPC.

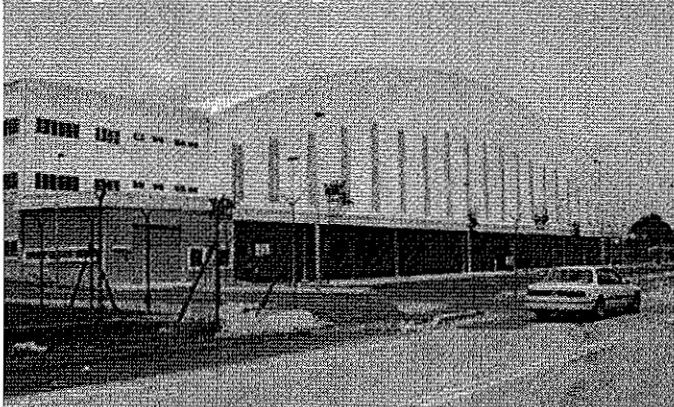

Hangar in Subang, Selangor as constructed by our Group



KT Prima Business Centre, Terengganu as constructed by our Group

4.5.3.3 Ongoing Project

As at the LPD, our ongoing construction of buildings project has contract sum of approximately RM110.70 million. Details are as follows:-

No.	Project Name	Scope of Work	Customer	#Total Contract Value (RM '000)	Project Start Date	Expected Completion Date	Approximate Percentage of Completion
1.	Damai 88, Ampang	Superstructure and other finishing works including M&E and interior design works	D.J. Design & Supplier Sdn Bhd	110,700	April 2013	August 2015	85%
Total				110,700			

Note:-

- # Total contract value includes variations orders.



Artist's impression of the ongoing construction of Damai 88 service apartments in Ampang, Kuala Lumpur as undertaken by our Group

4. INFORMATION ON OUR GROUP (Cont'd)

4.5.4 Manufacture and Installation of Prefabricated Building System

We are involved in the manufacture and installation of prefabricated building system, which contributed approximately RM8.78 million or 2.99% of our Group's total revenue for FYE 2014.

The prefabricated building system is a construction process where a large proportion of the building is mass-produced off-site as prefabricated components, which are then installed on-site to complete the building.

Our subsidiary MM2 Building System is involved in manufacturing of prefabricated building system and our subsidiary MM2 Builders is involved in installing the prefabricated building system. Our prefabricated building system manufacturing plant is located in Nilai.

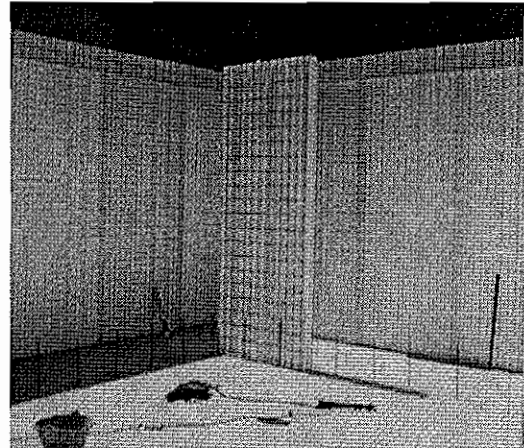

On-site installation of our prefabricated building system

The technology that is being used by us to manufacture the prefabricated building system is as detailed in Section 4.9.4 of this Prospectus.



Wall panel

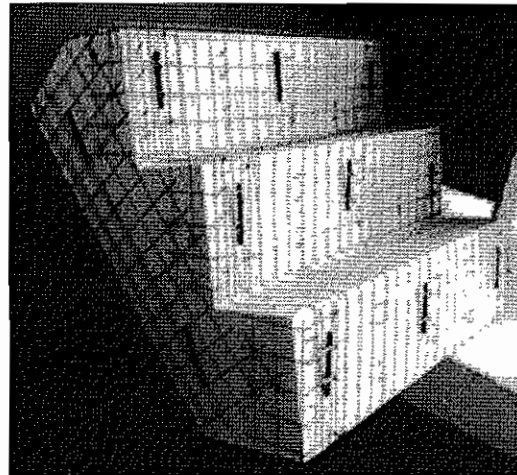

Stairs panel

[THE REST OF THIS PAGE IS INTENTIONALLY LEFT BLANK]

4. INFORMATION ON OUR GROUP (Cont'd)

Our prefabricated building system has the following characteristics and advantages over conventional construction methods:-

- (a) Easy to handle as the panels are relatively light;
- (b) Shorter installation time;
- (c) Versatility in design as the foam panels can be cut into the desired shape easily;
- (d) Able to support heavy loads;
- (e) Strong resistance to fire;
- (f) Earthquake and blast resistance;
- (g) Provides heat insulation, which reduces energy consumption for heating and cooling; and
- (h) Provides good sound insulation.

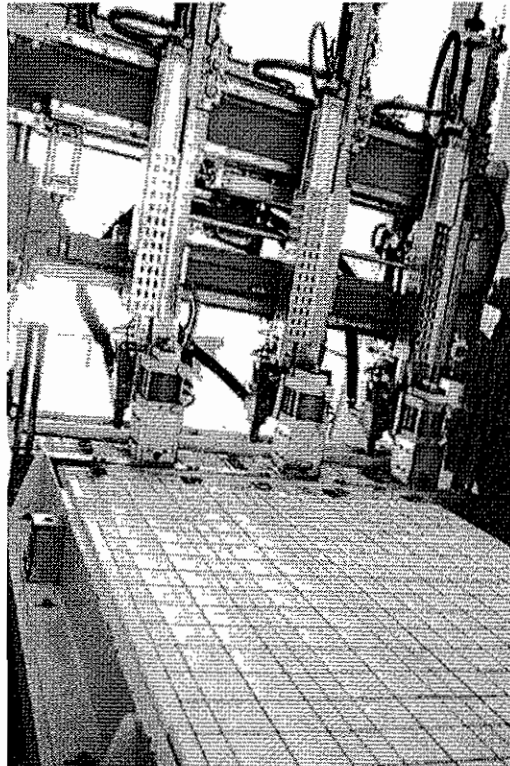

Spot welding machine to fabricate various types of panels

[THE REST OF THIS PAGE IS INTENTIONALLY LEFT BLANK]

4. INFORMATION ON OUR GROUP (Cont'd)

4.5.4.1 Completed Projects

Since the commencement of our prefabricated building system operations in 2012, our completed projects for the manufacture and installation of prefabricated building system are detailed as follows:-

No.	Project Name	Scope of Work	Customers	⁽¹⁾ Total Contract Value (RM'000)	Project Start Date	⁽²⁾ Project Completion Date
1.	Supplies of prefabricated building system to Jasin, Melaka	Supplies of prefabricated building system	Arah Semangat Sdn Bhd	2,530	September 2012	Not applicable – supply only
2.	Tzu Chi Building, Kepong	Manufacture and installation of prefabricated building system	Putra Perdana Construction Sdn Bhd	29	October 2013	Not applicable – supply only
3.	Office block at Seksyen 67, Jalan Inai, Kuala Lumpur	Manufacture and installation of prefabricated building system	Pesona Metro Sdn Bhd	227	December 2013	April 2014
4.	International University College of Automotive at Pahang	Manufacture and installation of prefabricated building system	Hicom Builders Sdn Bhd	1,394	March 2014	⁽³⁾ May 2015
5.	Budget hotel at PJ 21 Commercial Centre	Manufacture and installation of prefabricated building system	Original Heritage Sdn Bhd	77	April 2014	December 2014
6.	Factory, warehouse and office building at Kawasan Perindustrian Kundang, Gombak	Manufacture and supply of prefabricated building system	Unjur Metro Sdn Bhd	537	June 2014	Not applicable – supply only
7.	100 units of single storey terrace house under the Perumahan Generasi Baharu Felda Bukit Tajau, Pahang	Manufacture and supply of prefabricated building system	Kasyaf Bina Sdn Bhd	942	June 2014	Not applicable – supply only

Notes:-

- (1) Total contract value includes variations orders.
- (2) Based on issuance of the CPC.
- (3) Physical construction completed but pending issuance of CPC

[THE REST OF THIS PAGE IS INTENTIONALLY LEFT BLANK]

4. INFORMATION ON OUR GROUP (Cont'd)

4.5.4.2 Ongoing Projects

As at the LPD, our ongoing prefabricated building system projects have a total contract sum of approximately RM60.66 million. Details are as follows:-

No.	Project Name	Scope of Work	Project Owner	#Total Contract Value (RM '000)	Project Start Date	Expected Completion Date	Approximate Percentage of Completion
1.	Pulau Redang 5-storey flat	Design, manufacture and installation of prefabricated building system	Tunjang Jitu Sdn Bhd	27,975	April 2012	September 2015	78%
2.	Pulau Perhentian 5-storey flat	Design, manufacture and installation of prefabricated building system	Tunjang Jitu Sdn Bhd	32,686	April 2012	November 2015	25%
Total				60,661			

Note:-

Total contract value includes variations orders.

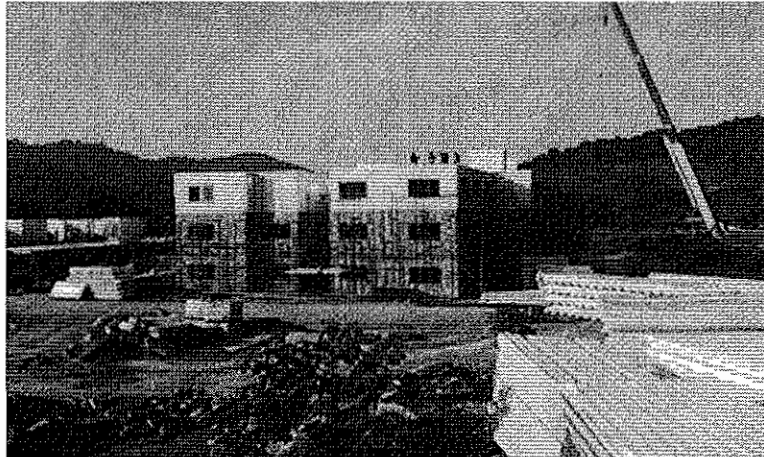

Ongoing construction of 5-storey flats in Pulau Redang, Terengganu using our prefabricated building system

[THE REST OF THIS PAGE IS INTENTIONALLY LEFT BLANK]

4. INFORMATION ON OUR GROUP (Cont'd)

4.6 OUR BUSINESS AND OPERATION PROCESSES

The process flow for our bore piling operation is depicted in the diagram below:-

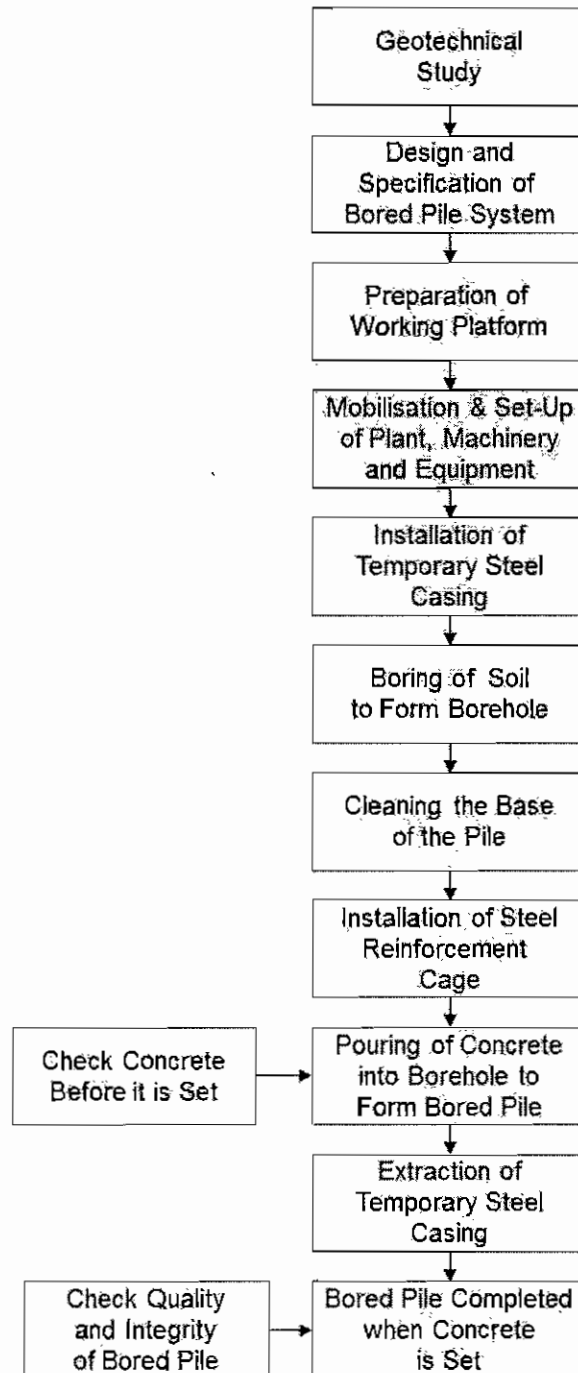

The first step in bore piling is to undertake a geotechnical study to determine the characteristics of the soil, bedrock and underground water table, and of surrounding environment and topography in terms of overburden, slope and water runoff.

4. INFORMATION ON OUR GROUP (Cont'd)

This will be followed by the design and technical specification for each bored pile as well as the entire system of piles for supporting the superstructure. The design and technical specification will take into consideration the findings from the geotechnical study. Factors that affect the environment such as noise and vibration, and preventing effects on adjoining structures during pile construction are also taken into consideration.

We prepare the working platform before actual piling work commences. This is done to ensure that the site can handle our machinery and equipment, and has a safe, efficient and effective working environment.

The bore piling process starts with mobilisation and setting up of our bentonite mixing plant, machinery and equipment. The location selected must be suitable and properly prepared. The site should be accessible and clear of obstructions and other hazards. The load bearing capacity of the ground should be sufficient to support the weight of the plant, machinery, equipment and delivery trucks. If the site is on a slope, it should be within the operating parameters of the equipment.

The first step in creating the bore pile is the installation of a cylindrical steel casing into the ground. This steel casing serves as a temporary formwork to hold the concrete when the concrete is poured into the bored hole. A service crane or vibratory hammer is used to drive the steel casing into the ground to the required depth until it reaches the support of the hard rock. The hard rock supports the steel casing during the drilling process and supports the bored pile when it is completed. About one meter of the steel casing is left protruding from the ground.

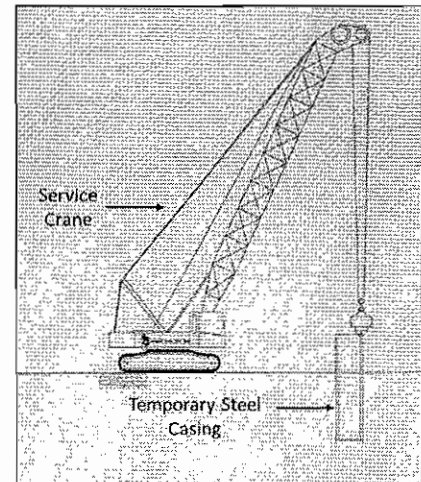

Installation of Temporary Casing

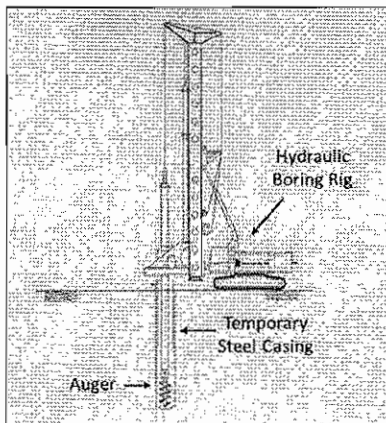

Boring of soil to form a borehole

A drilling tool is then used to form the borehole. The drilling tool comprises an auger bit at the end of the drill shaft to cut into the soil, while the screw-like shaft is used to remove the soil within the casing. The soil surrounding the outside of the borehole is prevented from collapsing into the borehole by the previously installed steel casing. If the casing is not long enough to reach the required depth in the ground, bentonite slurry will be used to support the soil below the casing. Once it is drilled to the specified depth, the bottom of the shaft is cleaned using a drilling bucket.

[THE REST OF THIS PAGE IS INTENTIONALLY LEFT BLANK]

4. INFORMATION ON OUR GROUP (Cont'd)

Once the borehole is ready, a reinforcement cage made of steel rods fitted with a spacer is placed down the borehole using a crane. The spacer is wired to the cage to provide lateral support to the reinforcement cage. Subsequently, concrete with the specified composition is poured into the borehole under high pressure to form the bored pile. Several checks and inspections, including fluid density and concrete slump tests are carried out during the concreting process. The temporary steel casing is removed using a vibrating hammer once the concrete has set.

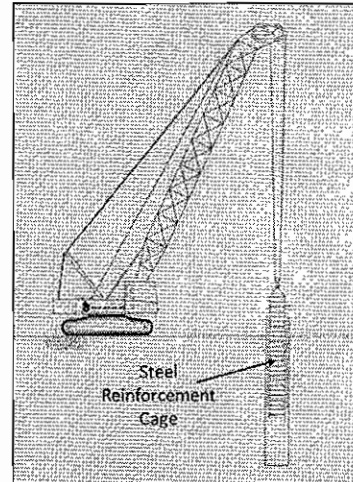

Installation of steel reinforcement cage

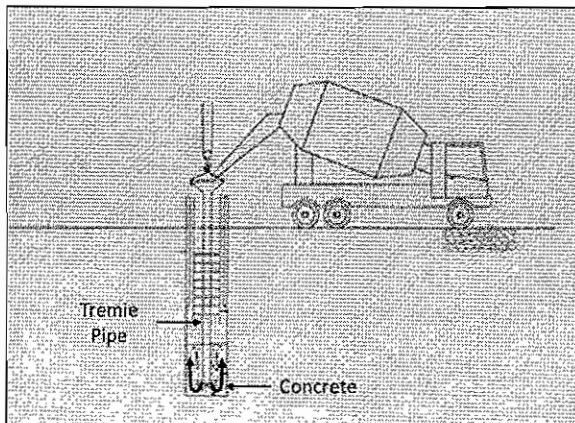

Pouring of concrete into borehole

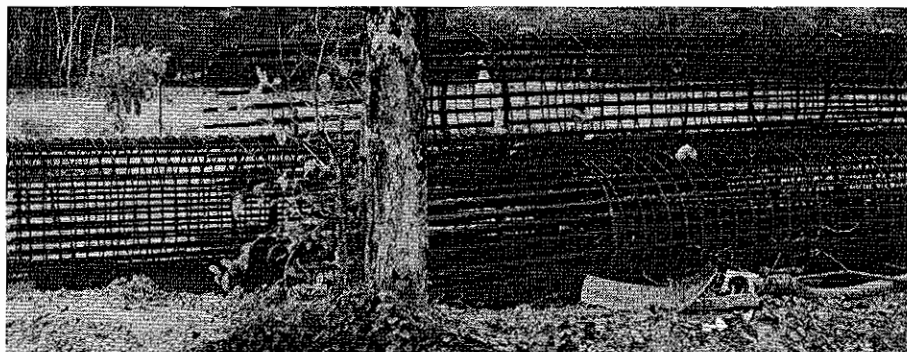

Reinforcement Cage

In addition, we also carry out proof drilling through core drilling to check the quality of the concrete, contact between the rock and concrete, as well as the quality of the rock beneath the lowest point of the bored pile (also known as the "toe").

We carry out tests to check the integrity of the bored pile shaft, including high strain dynamic load test, pile integrity test and sonic logging test. These tests are commonly used to detect concrete defects that may affect the overall performance of the bored pile, such as honey combing, cold joints and cracks. All of these tests are undertaken by independent testing parties together with our in-house technical personnel.

4. INFORMATION ON OUR GROUP (Cont'd)

4.7 QUALITY ASSURANCE MANAGEMENT

We place strong emphasis on the quality of our work and services, and safety of our workers. We adopt the following approaches to ensure certain quality and safety standards are maintained and adhered to:-

- (a) We have in-house Engineers to ensure product design and construction quality.
- (b) We have built quality checks and procedures into all our work processes, including inspection of input materials, machinery and equipment, site preparation, process of construction and testing of finished work and products.
- (c) We have instituted workplace safety procedures covering worksite procedures, machine and equipment operation, and workers' safety practices.
- (d) We have a team of professionals comprising Engineers, Surveyors, Site Managers and Supervisors to implement our quality and safety standards and procedures.

As part of our commitment to product quality, we have obtained the relevant quality accreditation as follows:-

Company within our Group	Accreditation	Scope	Certification Body	Valid Until
Ikhmas Jaya	ISO 9001:2008	Provision of civil engineering project management and building construction services, including construction of bridges, dams and reservoirs, pipe laying, water treatment plants, flood mitigation works, oil and gas works, and foundation works	KGS Certification Sdn Bhd	25 November 2017
Rekavista				

The quality accreditations indicate that our Group adopts certain processes and procedures to ensure that quality standards are maintained internally. This provides customers with the comfort and assurance of the quality of our Group's construction work.

As at the LPD, we have 37 Engineers and 19 Quantity Surveyors who are jointly involved in our in-house quality control throughout the construction process. Six (6) of these Engineers being primarily responsible for the proper implementation of our Group's quality assurance/control policy. We also have 21 Health, Safety and Environment personnel responsible for minimising occupational hazards, maintaining safety compliance of project sites, as well as preventing damage to the surrounding environment.

Our emphasis on work place and work practices safety has been effective and recognised, as indicated by the awards we received from our customers as disclosed in Section 4.3.3(f) of this Prospectus.

4.8 R&D

As we are mainly engaged in piling and foundation works, and construction of bridges and buildings, R&D is not relevant to our business. As a result, we do not carry out any specific R&D activities and therefore do not formulate any R&D policy for our business operations. Furthermore, we did not recognise any R&D expenditure for FYE 2011 to FYE 2014.

4. INFORMATION ON OUR GROUP (Cont'd)

4.9 TECHNOLOGY USED

We mainly utilise the following technologies in our core business operations:-

- (a) Piling;
- (b) Basement construction;
- (c) Bridge construction; and
- (d) Prefabricated building system technology.

4.9.1 Piling

We employ a number of technologies for our piling including the following:-

(a) Rotary

Rotary bored piling method is where the piling rig is equipped with a bar that moves vertically. A short length of auger or a digging bucket is held at the end of bar. The auger or bucket excavates the ground when it is rotated. The bar is then retracted, the rig is slewed and then the excavated soil is ejected by spinning the bar and tool rapidly. This action is repeated until the soil is excavated to the required depth. Usually, temporary casing or stabilising mud such as bentonite suspension is used to support the excavate area and to prevent it from collapsing. The casing or slurry is usually extracted as or immediately after the bore is filled with concrete.

(b) Continuous Flight Auger

In the continuous flight auger piling method, a pile is formed by drilling into the ground with a full length auger. In this method, the auger stays in the bored hole until the final depth. When the drilling is complete, concrete is injected through the hollow stem of the auger under pressure and the pressure is maintained as the auger is extracted. A steel reinforcing cage is then inserted into the concrete before it hardens.

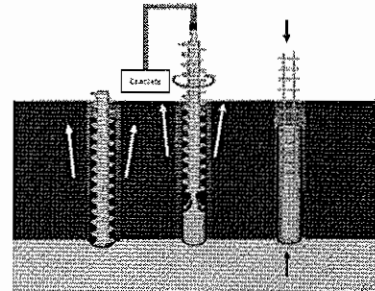

(c) Micropiling

Micropile is a small pile generally with diameter of less than 300 mm. It is cast in situ using the same process as bored piles. Micropiles have smaller bearing capacity compared to bored piles. Micropiles are typically used to strengthen the foundation of an existing building or structure. Due to the smaller size of the machine used, micropiles are also frequently used at sites that are difficult to access.

(d) CSM

CSM technology is a technique which injects and blends binding agents (generally cement) with existing soil in situ to produce a final hardened product. Once hardened, these mixed soils are capable of retaining soils and water for cut-off walls, earth retaining walls and for soil improvement. One of the main advantages of CSM technology is that no vibrations are induced during construction, which is an important consideration in urban areas.

[THE REST OF THIS PAGE IS INTENTIONALLY LEFT BLANK]

4. INFORMATION ON OUR GROUP (Cont'd)

4.9.2 Basement

We make use of the following basement construction technologies:-

(a) Top-Down

In the top-down method, the ground floor level is constructed first. Once the ground floor is complete, soil is excavated below the ground floor level to create a cavity to construct the next level down. This process continues until it reaches the desired depth.

(b) Bottom-Up

In the bottom-up method where soil is excavated to create a cavity for the construction of the basement.

4.9.3 Bridge Construction

We employ several types of bridge design technology including the following:-

(a) Beam Bridge

A beam bridge utilises the simplest bridge span structural form. Each bridge span has a support on each end. Other supports such as piers may also hold up the bridge between the two ends.

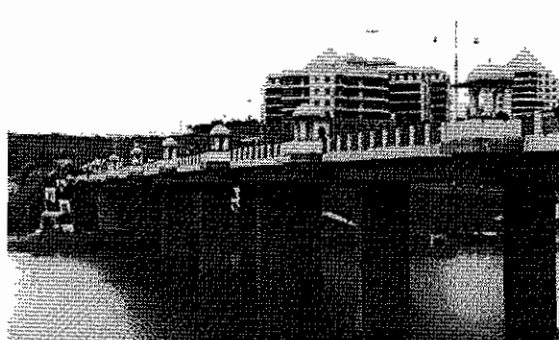
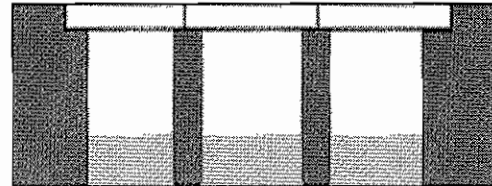

Beam bridge in Putrajaya as constructed by our Group

(b) Girder Bridge

Girder bridge comprises girders placed on bridge abutments and piers. A bridge deck is built on top of the girders to carry traffic. Girder bridges are currently the most commonly built and utilised type of bridge in the world, where it is commonly used in constructing highway flyovers and modern elevated structures for light rail transport. The two (2) most common types of girder bridges are I-beam girder bridge and box-girder bridge.

[THE REST OF THIS PAGE IS INTENTIONALLY LEFT BLANK]

4. INFORMATION ON OUR GROUP (Cont'd)

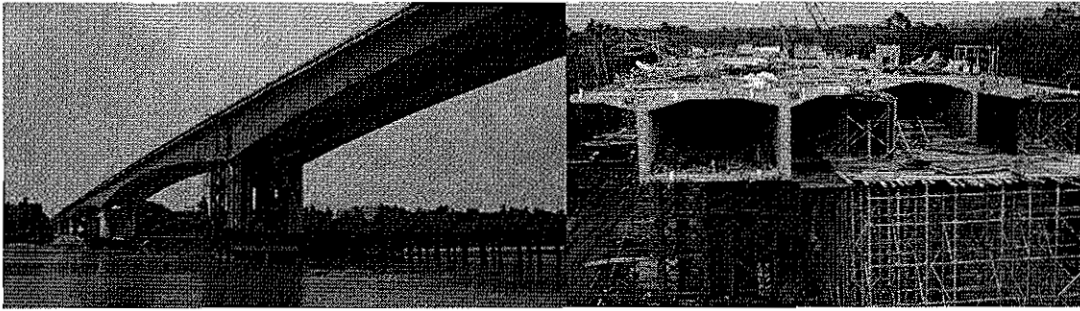

Chenor Bridge using box-girder design as constructed by our Group

(c) **Truss Bridge**

Truss bridge is a bridge that uses truss elements connected as triangular units with joints. They are generally more economical than beam bridges.

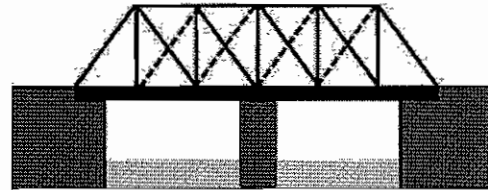

(d) **Arch Bridge**

Arch bridge is an arched structure built beneath the bridge's roadway to provide support.



Reinforced concrete arch bridge in Cyberjaya as constructed by our Group



Arch beam bridge in Putrajaya as constructed by our Group

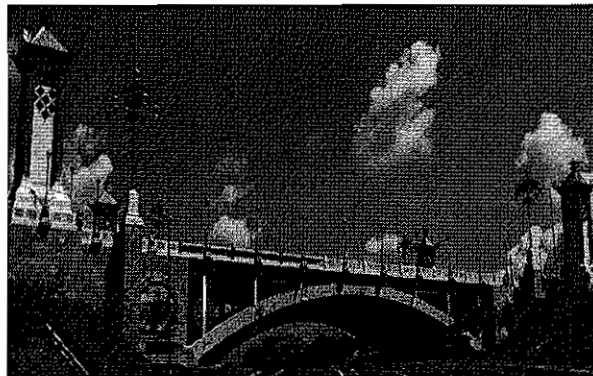

Steel arch bridge in Cyberjaya as constructed by our Group

4. INFORMATION ON OUR GROUP (Cont'd)

(e) Swing Bridge

Swing bridge rotates about a centre pier to create an opening. One of the advantages of a swing bridge is that it has the lowest power requirement among all movable bridges.

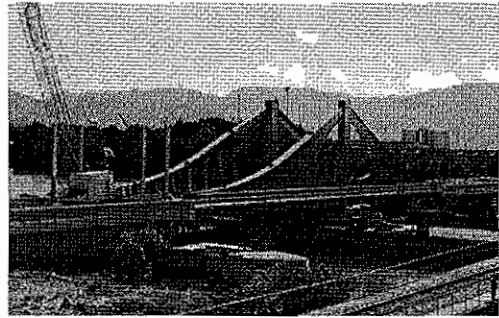

Swing bridge design used for the construction of railway track in Prai, Penang as undertaken by our Group

In addition, we also employ a number of bridge construction technologies including the following:-

(i) Form Traveller System

The form traveller system is a movable formwork system for cast in situ construction that can be used for free cantilever bridge segmental construction of post-tensioned box girder. The bridge span is constructed on opposite directions simultaneously and it is facilitated by using the top of a pier as the initial anchor point with two separate form travellers. The bridge construction is conducted by moving each pair of form travellers further away from their respective pier in tandem so the weight of each cantilever is always balanced. Form travellers are preferred for constructing bridge spans over deep valleys, waterways and roads where access from the ground is a challenge and the number of piers is limited.

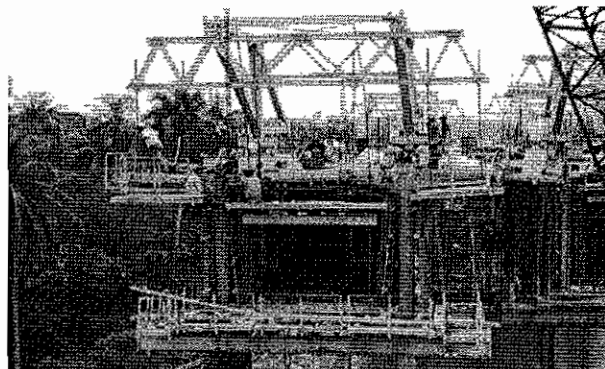

Construction of Chenor Bridge using the Form Traveller System as undertaken by our Group

(ii) Self-climbing Formwork System

Self-climbing formwork system operates in a similar manner to form travellers. However, it is used to vertically build piers, as opposed to laterally building bridge decks. Self-climbing formwork is installed on site and can be used to construct the entire height of a new cast in-place concrete pier. This formwork system elevates itself periodically with a hydraulic system. The system is static when the pouring of concrete is in process.

4. INFORMATION ON OUR GROUP (Cont'd)

(iii) Slipform System

Slipform system is a formwork system similar to self-climbing formwork system, except that the formwork is moving slowly upwards at all times as concrete is being poured into the formwork. As new concrete is being poured into the formwork, the concrete that was previously poured starts to harden. As the formwork moves upwards it creates a space in the top for more concrete to be poured in and at the same time leaving the harden concrete at the bottom. This process is repeated slowly and continuously such that a continuous concrete structure is created.

Slipforming enables continuous and non-interrupted cast in-place concrete structures which have superior performance characteristics.

(iv) Launching Gantry

Launching gantry is a bridge formwork system that performs sequential construction (on rollers or track) of a continuous deck at one end of the bridge. As each new section is added, the whole deck is pushed or pulled out (usually over multiple spans). This is commonly used for the construction of elevated highways and railway lines.

4.9.4 Prefabricated Building System Technology

Prefabricated building system technology is a construction process where a large proportion of a building is mass-produced off-site as prefabricated components. These components are installed on-site to complete the building.

Our prefabricated building system utilises the proprietary "M2 EMMEDUE® Advanced Building System" machinery and equipment from our supplier, EMMEDUE® S.p.A. in Italy. Our supplier is a specialist in manufacturing and marketing seismic resistant and thermal-insulation building systems. The basic element of the prefabricated building system is a modular panel. Each panel consists of two (2) welded galvanised steel meshes that are joined by connectors. A layer of appropriately shaped foam polystyrene (expanded polystyrene) is sandwiched in the middle of the two steel meshes.

The prefabricated building system is manufactured at our factory in accordance to technical specifications. Completed panels are transported to the construction site for installation. Once the panels are installed, the building or structure is finished in accordance to the customer's requirements. Finishing commonly involves rendering the outer surfaces of the building or structure with cement.

As our prefabricated building system is modular, we have specific design for the following types of panels:-

- (a) Single panel;
- (b) Double panel;
- (c) Stair panel;
- (d) Landing panel;
- (e) Floor panel; and
- (f) Curved panel.

4. INFORMATION ON OUR GROUP (Cont'd)

We can use various combinations of our modular panels to construct most, if not all, parts of a building or structure (except the roof).



Single Panel



Double Panel

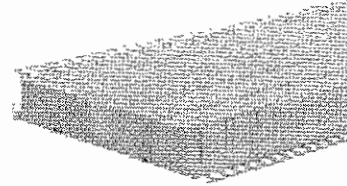

Floor Panel

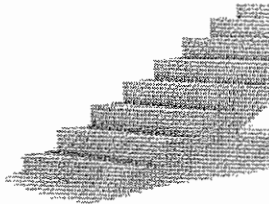

Stair Panel

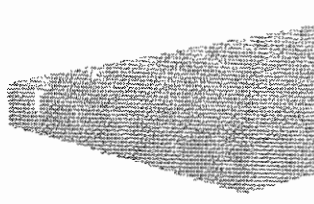

Landing Panel

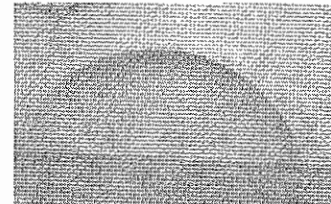

Curved Panel

The advantages of prefabricated building system over conventional building methods include the following:-

- (i) less labour is required to construct buildings or structures, which reduces labour costs;
- (ii) reduction in volume of building materials used, which would minimise wastage;
- (iii) reduced environmental impact and better construction site cleanliness;
- (iv) better quality control by using standardised prefabricated building system components;
- (v) promotes a safer and more organised construction site; and
- (vi) shorter construction time period as the major components are prefabricated.

[THE REST OF THIS PAGE IS INTENTIONALLY LEFT BLANK]

4. INFORMATION ON OUR GROUP (Cont'd)

4.10 RAW MATERIALS AND MAJOR SUPPLIERS

4.10.1 Types, Sources and Availability of Raw Materials/ Input

The following are the major types of raw materials and services for our business operations for FYE 2014:-

	Value of Purchases for FYE 2014 (RM'000)	Proportion of Our Group's Total Purchases (%)	Sources of Supply	
			Local (%)	Import (%)
Materials and Consumables	104,443	52.70	100.00	-
Building and Construction Materials	98,132	49.52	100.00	-
- Steel and other metal materials ⁽¹⁾	60,038	30.30	100.00	-
- Concrete and cement	21,960	11.08	100.00	-
- Wood materials ⁽²⁾	2,579	1.30	100.00	-
- Scaffolding and beams	1,528	0.77	100.00	-
- Piling tools	2,724	1.37	100.00	-
- Other building and construction materials ⁽³⁾	9,303	4.70	100.00	-
Diesel	5,841	2.94	100.00	-
Materials to Manufacture Prefabricated Building System	470	0.24	100.00	-
- Galvanised and steel wire	176	0.09	100.00	-
- Polystyrene materials	294	0.15	100.00	-
Services	93,725	47.30	99.99	0.01
Subcontracted works ⁽⁴⁾	79,916	40.33	99.99	0.01
Rental of Machinery and Equipment	13,223	6.67	100.00	-
Repair and Maintenance Services	586	0.30	100.00	-
Total⁽⁵⁾	198,168	100.00	100.00	(6)

Notes:-

- (1) Include steel bar, wire mesh, steel products and pipes.
- (2) Include plywood and timber.
- (3) Include bricks, sand, crusher run, quarry dust, hardware, accessories and others.
- (4) Include subcontractors that provide both labour and materials.
- (5) The above purchases exclude electricity and other utilities.
- (6) Insignificant.

For the FYE 2014, purchases of materials, consumables and services for our business operations amounted to a total of approximately RM198.17 million. We sourced approximately 100.00% of our Group's total purchases of materials, consumables and services from local suppliers.

4. INFORMATION ON OUR GROUP (Cont'd)

For FYE 2014, purchases of materials and consumables accounted for approximately RM104.44 million or about 52.70% of our Group's total purchases of materials, consumables and services, all of which were sourced locally. Our purchases of materials and consumables include building and construction materials, consumables and materials to manufacture prefabricated building system.

For FYE 2014, purchases of building and construction materials accounted for approximately RM98.13 million or 49.52% of our Group's total purchases of materials, consumables and services. The building and construction materials that we purchased during the FYE 2014 included steel and other metal materials, concrete and cement, wood materials, scaffolding and beams, piling tools and other building and construction materials.

For FYE 2014, diesel and materials to manufacture prefabricated building system accounted for approximately RM5.84 million or 2.94% and RM0.47 million or 0.24% of our Group's total purchases of materials, consumables and services respectively.

For FYE 2014, purchases of services accounted for approximately RM93.73 million or 47.30% of our Group's total purchases of materials, consumables and services. Approximately 99.99% of these services were sourced locally while the remaining of approximately 0.01% was from an overseas service provider. Our purchase of services includes subcontracted works, rental of machinery and equipment, and repair and maintenance services.

For FYE 2014, subcontracted works accounted for approximately RM79.92 million or 40.33% of our Group's total purchases of materials, consumables and services. Rental of machinery and equipment accounted for approximately RM13.22 million or 6.67% of our Group's total purchases of materials, consumables and services while repair and maintenance services accounted for approximately RM0.59 million or 0.30%.

As at the LPD, we have not experienced any shortages in the supply of materials, consumables and services mentioned above.

4.10.2 Major Suppliers

The table below lists the suppliers of our Group that accounted for 10.0% or more of our Group's total purchases for the last four (4) FYE 2011 to FYE 2014:-

No.	Supplier Name	Length of Relationship (Years)	FYE 2011		FYE 2012		FYE 2013		FYE 2014	
			Purchases (RM'000)	Proportion of Our Group's Total Purchases (%)	Purchases (RM'000)	Proportion of Our Group's Total Purchases (%)	Purchases (RM'000)	Proportion of Our Group's Total Purchases (%)	Purchases (RM'000)	Proportion of Our Group's Total Purchases (%)
1.	Syarikat Logam Unitrade Sdn Bhd	3	-	-	4,239	3.26	3,627	2.20	20,504	10.35
2.	Setia Precast Sdn Bhd	3	-	-	9,660	7.44	39,789	24.13	13,778	6.95
Total purchases of our Group			92,323	100.00	129,887	100.00	164,905	100.00	198,168	100.00

4. INFORMATION ON OUR GROUP (Cont'd)

Our Group is dependent on Syarikat Logam Unitrade Sdn Bhd as it accounted for approximately 10.35% of our Group's total purchases of materials, consumables and services for FYE 2014. Our Group is also dependent on Setia Precast Sdn Bhd as it accounted for approximately 24.13% of our Group's total purchases of materials, consumables and services for FYE 2013.

The following factors help to mitigate our dependency on our major suppliers:-

- (a) Syarikat Logam Unitrade Sdn Bhd
 - (i) We have been dealing with Syarikat Logam Unitrade Sdn Bhd for approximately three (3) years for the purchase of steel bar, pipe and other accessories. This indicates a stable and continuing business relationship with Syarikat Logam Unitrade Sdn Bhd; and
 - (ii) There are many other suppliers of steel bar, pipe and other accessories in the market. We can easily source steel bar, pipe and other accessories from other suppliers should the need arises.
- (b) Setia Precast Sdn Bhd
 - (i) As part of the arrangements set out in our contract with Setia Precast Sdn Bhd for the Parcel C of the KL Eco City project, Setia Precast Sdn Bhd is our supplier for the ready mixed concrete and steel bars that we use in the project. Our dependency on Setia Precast Sdn Bhd was reduced to approximately 6.95% of our Group's total purchases of materials, consumables and services for FYE 2014. Since the physical completion of the Parcel C of the KL Eco City project in May 2014, we have not purchased materials, consumables and services from Setia Precast Sdn Bhd for use in any of our other projects; and
 - (ii) There are many other suppliers of ready mixed concrete and steel bars in the market. We can easily source ready mixed concrete and steel bars from these other suppliers.

4.11 MARKETING ACTIVITIES AND MAJOR CUSTOMERS

4.11.1 Marketing Strategies

We utilise the following marketing strategies and positioning to sustain and expand our business:-

- (a) Position ourselves as specialists in bore piling providing total solutions for foundation works and substructures.
- (b) Provide total solutions supported by the following:-
 - (i) our in-house technical Engineers and professionals capable of undertaking design and construction works for piling and foundation, and construction of bridges and buildings;
 - (ii) in-house fleet of machinery and equipment for timely and ease of deployment; and
 - (iii) synergistic capabilities and experience in designing and constructing substructures and superstructures.

4. INFORMATION ON OUR GROUP (Cont'd)

- (c) Address business opportunities from both the public and private sectors by maintain our registrations with CIDB and other relevant regulatory bodies.
- (d) Target large projects by maintaining our Grade 7 CIDB registration, which allows us to bid for any contracts without restrictions. Since commencement of our business and as at the LPD, we have been awarded 13 projects with contract sum exceeding RM50 million per project.
- (e) While we will continue emphasise on winning jobs in Kuala Lumpur, Selangor and Putrajaya, we will also market our services to customers in other states and territories in Malaysia.
- (f) Continuously improve the quality of our work and services.
- (g) Maintain a high standard of work place safety and minimising adverse impact on the environment.

Our marketing strategies and positioning are aimed at:-

- (i) providing sustainable growth for our business;
- (ii) attaining and maximising economies of scale by securing large projects, which will also help to maximise the utilisation of our fleet of machinery and equipment; and
- (iii) enlarging our addressable market by catering to both the private and public sectors, as well as foray into other states and territories outside the central region of peninsular Malaysia.

4.11.2 Distribution Channel Strategy

We adopt a direct and indirect distribution channel strategy to market our products and services as depicted below:-

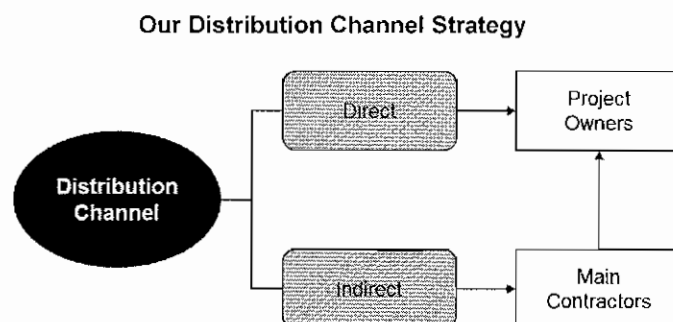

Our portfolio of services requires us to bid for jobs directly from project owners as well as indirectly through main contractors.

Piling and foundation works are commonly integral parts of a total project package that is awarded to a main contractor. As such, we bid for piling and foundation works contracts from the main contractors. However, in some cases, we bid for piling and foundation work contracts directly with the project owners but work under a main contractor.

We commonly bid for construction of building contracts directly from the project owners. In such a situation, we are the main contractor for the project. We may subcontract out some portions of the work to external suppliers.

4. INFORMATION ON OUR GROUP (Cont'd)

Contracts for the construction of bridges are similar to contracts for piling and foundation works, where the total package is awarded to a main contractor. As such, we bid for work from the main contractors. However, in some cases, we bid directly with the project owner but work under a main contractor.

For the FYE 2014, revenue derived through contracts secured from main contractors through the indirect distribution represented approximately 70.06% of our Group's total revenue. Revenue derived through contracts secured from project owners through the direct distribution channel accounted for the remaining of approximately 29.94% of our Group's total revenue.

4.11.3 Major Customers

For the FYE 2014, our customer base comprises the following types in various states and territories in Malaysia:-

(a) Types

- (i) Public and private sector main contractors; and
- (ii) Public and private sector project owners.

(b) States and Territories

- (i) Kuala Lumpur;
- (ii) Selangor;
- (iii) Putrajaya;
- (iv) Terengganu;
- (v) Penang;
- (vi) Pahang;
- (vii) Perak; and
- (viii) Melaka

Our ability to service the full spectrum of both public and private sectors customers across a number of states and territories provide growth opportunities for our business operations.

[THE REST OF THIS PAGE IS INTENTIONALLY LEFT BLANK]

4. INFORMATION ON OUR GROUP (Cont'd)

The table below lists the customers representing 10.0% or more of our Group's total revenue over any of the last four (4) FYE 2011, FYE 2012, FYE 2013 and FYE 2014:-

No.	Customer Name	Length of Relationship (Years)	FYE 2011		FYE 2012		FYE 2013		FYE 2014	
			Revenue (RM'000)	Proportion of Our Group's Total Revenue (%)	Revenue (RM'000)	Proportion of Our Group's Total Revenue (%)	Revenue (RM'000)	Proportion of Our Group's Total Revenue (%)	Revenue (RM'000)	Proportion of Our Group's Total Revenue (%)
1.	Konsortium Skypark Link Sdn Bhd – Lion Pacific Sdn Bhd	1	-	-	-	-	-	-	70,963	24.18
2.	D.J. Design & Suppliers Sdn Bhd	3	-	-	27,775	13.69	15,683	7.64	47,777	16.28
3.	UEM Construction Sdn Bhd	3	-	-	-	-	33,088	16.11	35,305	12.03
4.	Setia Precast Sdn Bhd	3	-	-	45,210	22.29	85,304	41.54	31,245	10.65
5.	MMC-Gamuda Joint Venture	6	43,193	29.71	19,928	9.82	19,547	9.52	4,439	1.51
6.	Econpile (M) Sdn Bhd	4	3,253	2.24	29,535	14.56	5,276	2.57	2,086	0.71
7.	Denrich Naluri Rezeki JV	6	25,579	17.59	1,031	0.51	^(a) (291)	^(a) (0.14)	1,341	0.46
8.	Airod Sdn Bhd	4	9,598	6.60	23,058	11.37	7,265	3.54	-	-
9.	Tianjin Cement Industry (Malaysia) Sdn Bhd	4	29,286	20.14	^(a) (6)	^(b)	-	-	-	-
Total revenue of our Group			145,403	100.00	202,868	100.00	205,335	100.00	293,505	100.00

Notes:-

(a) Adjustments to previous year.

(b) Insignificant proportion.

For FYE 2011 to FYE 2014 collectively we have nine (9) customers that contributed 10.0% or more of our Group's total revenue.

For FYE 2014, we were reliant on four (4) customers, namely Konsortium Skypark Link Sdn Bhd – Lion Pacific Sdn Bhd, D.J. Design & Supplies Sdn Bhd, UEM Construction Sdn Bhd and Setia Precast Sdn Bhd and as they contributed approximately 24.18%, 16.28%, 12.03% and 10.65% respectively of our Group's total revenue.

The following factors mitigate against our Group's dependency on these customers:-

- (i) Our business is mainly project-based. As such, some customers may account for 10.0% or more of our Group's total revenue in some years as a project is being implemented. Revenue contribution from these customers will then typically be less than 10.0% of our Group's total revenue during the financial years where no projects are being implemented for the said customers.

4. INFORMATION ON OUR GROUP (Cont'd)

- (ii) Konsortium Skypark Link Sdn Bhd – Lion Pacific Sdn Bhd, who accounted for approximately 24.18% of our Group's total revenue for FYE 2014 is the main contractor for the Subang-Skypark Terminal Railway Track – Phase 1 project. This RM270 million project is expected to be completed in November 2015. Hence, our Group expects our dependency on Konsortium Skypark Link Sdn Bhd – Lion Pacific Sdn Bhd to be reduced from FYE 2016 onwards.
- (iii) D.J. Design & Supplies Sdn Bhd, who accounted for approximately 16.28% of our Group's total revenue for FYE 2014, is the project owner for the Damai 88, Ampang project, where we undertook the project's piling and substructure works as well as building construction works. We expect our dependency on D.J. Design & Supplies Sdn Bhd to be reduced from FYE 2016 onwards as the project is expected to be completed in August 2015.
- (iv) UEM Construction Sdn Bhd, who accounted for approximately 16.11% of our Group's total revenue for FYE 2013, is the main contractor for Package V8 of the Klang Valley Mass Rapid Transit Sungai Buloh-Kajang Line project. For the FYE 2014, the proportion of revenue contribution from UEM Construction Sdn Bhd to our Group's total revenue was lower as our Group's total revenue grew in the FYE 2014. As a result, our dependency on UEM Construction Sdn Bhd based on the percentage of revenue contribution was reduced to approximately 12.03% for the FYE 2014.
- (v) Setia Precast Sdn Bhd, who accounted for approximately 41.54% of our Group's total revenue for FYE 2013, is the main contractor for Parcel C of the KL Eco City project. As the project was completed in May 2014, our dependency on Setia Precast Sdn Bhd based on the percentage of revenue contribution, was reduced to approximately 10.65% for the FYE 2014.
- (vi) We have reduced our dependency on the other customers that accounted for more than 10.0% or more of our Group's total revenue for FYE 2011 and FYE 2012. These customers accounted for less than 10.0% of our Group's total revenue for the FYE 2013 and FYE 2014.
- (vii) In addition, we believe that our established track record as well as our continuing business relationship with our major customers will provide the basis for us to secure more contracts from these major customers for our continuing business growth.

4.12 SEASONALITY

We do not experience any material seasonality in our business as our business operations are mainly based on contractual arrangements.

4.13 BRANDS NAMES, TRADE MARKS, LICENCE AGREEMENTS AND TECHNICAL AGREEMENTS

As at the LPD, our Group does not have any brand name, patent, trademark, technical assistance agreement, franchise or any other intellectual property right.

As at the LPD, there are no other patents or licenses, industrial, commercial or financial contracts (including informal arrangements or understandings) or new manufacturing processes, which have been entered into by us that we are highly dependent on or that are material to our business and/or profitability.

4. INFORMATION ON OUR GROUP (Cont'd)

4.14 OUR GROUP'S PROPERTY, PLANT AND EQUIPMENT

4.14.1 Location of Principal Place of Business, Marketing and Production Facilities

As at the LPD, our Group's principal place of business, marketing and production facilities are as follows:-

No.	Registered Owner/ Landlord/ Tenant	Description/ Existing Use	Address	Period of Tenancy/ Rental Per Month	Approximate Land Area/ Built-Up Area (sqf)
1.	Ikhmas Jaya	Two (2) intermediate and one (1) corner adjoining units of 3-storey terrace shop/ office with basement car park/ Ikhmas Group's head office	Nos. 35, 37 & 39 Jalan PJU 1A/41B Pusat Dagangan NZX Ara Jaya, PJU 1A 47301 Petaling Jaya Selangor Darul Ehsan	-	6,039/ 20,351
2.	Tan Say Tuan & Sons Realty Sdn Bhd/ Ikhmas Jaya	A second floor unit of an intermediate 3-storey terrace shop/ office/ Site office	L-2-3, Block L No 2, Jalan PJU1A/41B Pusat Dagangan NZX Ara Jaya, PJU 1A 47301 Petaling Jaya Selangor Darul Ehsan	01.11.2014 to 31.10.2015/ RM1,100	Not applicable/ 1,905
3.	Accolade Technology Sdn Bhd/ Ikhmas Jaya	A first floor unit of an intermediate 3-storey terrace shop/ office/ Site office	No. 45-1 Jalan PJU1A/41B Pusat Dagangan NZX Ara Jaya, PJU 1A 47301 Petaling Jaya Selangor Darul Ehsan	01.07.2014 to 30.06.2015/ RM1,200 with an extension up to 07.07.2015 ⁽ⁱ⁾	Not applicable/ 1,800
4	Wong Kim Lan/ MM2 Building System	An intermediate unit of 1½-storey terrace factory/ MM2 Building System's office cum warehouse ⁽ⁱⁱ⁾	Lot 444 (PT 3422) Jalan Nilai 7/17 Kawasan Perindustrian Nilai 7 71800 Nilai Negeri Sembilan	01.10.2014 to 30.09.2016/ RM1,500	3,000/ 2,850
5.	Choong Yoon Keong and Chen Fern Fang/ MM2 Building System	An intermediate unit of 1½-storey terrace factory/ MM2 Building System's office cum warehouse ⁽ⁱⁱ⁾	Lot 445 (PT 3423) Jalan Nilai 7/17 Kawasan Perindustrian Nilai 7 71800 Nilai Negeri Sembilan	01.10.2014 to 30.09.2016/ RM1,500	3,000/ 2,850

Notes:-

- (i) Our Group intends to further extend our tenancy for another one (1) year up to 30 June 2016 and is in the midst of signing the agreement with the landlord.
- (ii) Our Group intends to relocate our prefabricated building system manufacturing operations at the rented factory to our own manufacturing facility to be located at Lot 299, Jalan Segenting, 42500 Teluk Panglima Garang, Selangor Darul Ehsan as disclosed in item 4 of Section 4.14.2 of this Prospectus by the third quarter of 2016. Please refer to Section 4.18.2 of this Prospectus for further details.

[THE REST OF THIS PAGE IS INTENTIONALLY LEFT BLANK]

4. INFORMATION ON OUR GROUP (Cont'd)

4.14.2 Land and buildings

As at the LPD, our Group owned the following properties:-

Registered Owner/ Beneficial No. Owner	Address/ Title Identification	Description/ Existing Use	Approximate Age of Building/ Tenure/ Approximate Land Area/ Approximate Built-up Area (sqft)	Restriction/ Interest/ Encumbrances	Date of Issuance of CF	Audited NBV as at 31.12.2013 (RM)	Audited NBV as at 31.12.2014 (RM)	Market Value/ Date of Valuation/ Method of Valuation (RM)	Revaluation Surplus as at 31.12.2013 (RM)	Notes (1) and (5)
1. Ikhmas Jaya	No. 35, Jalan PJU 1A/41B, Pusat Dagangan NZX, Ara Jaya, PJU 1A, 47301 Petaling Jaya, Selangor Darul Ehsan/ HSD 233616, Lot No. PT 33386, Mukim Damansara, District of Petaling and State of Selangor Darul Ehsan		7 years/ Freshhold/ 2,439/ 8,475	None/ Charged to Hong Leong Berhad	17.12.2007	1,916,876	1,896,325	2,580,000/ 06.03.2014 and 01.06.2015/ Cost Method and Investment Method	663,124	Notes (1) and (5)
2. Ikhmas Jaya	No. 37, Jalan PJU 1A/41B, Pusat Dagangan NZX, Ara Jaya, PJU 1A, 47301 Petaling Jaya, Selangor Darul Ehsan/ HSD 233615, Lot No. PT 33385, Mukim Damansara, District of Petaling and State of Selangor Darul Ehsan	Two intermediate and one (1) corner adjoining units of 3-storey terrace shop/ office with basement car park/ Our Group's head office	7 years/ Freshhold/ 1,800/ 5,938	None/ Caveat lodged in favour of Hong Leong Berhad Charged to Hong Leong Berhad	17.12.2007	1,511,600	1,495,073	1,950,000/ 06.03.2014 and 01.06.2015/ Cost Method and Investment Method	438,400	Notes (1) and (5)
3. Ikhmas Jaya	No. 39, Jalan PJU 1A/41B, Pusat Dagangan NZX, Ara Jaya, PJU 1A, 47301 Petaling Jaya, Selangor Darul Ehsan/ HSD 233614, Lot No. PT 33384, Mukim Damansara, District of Petaling and State of Selangor Darul Ehsan		7 years/ Freshhold/ 1,800/ 5,938	None/ Caveat lodged in favour of OCBC Bank (Malaysia) Berhad Charged to OCBC Bank (Malaysia) Berhad	17.12.2007	1,511,600	1,495,073	1,950,000/ 06.03.2014 and 01.06.2015/ Cost Method and Investment Method	438,400	Notes (1) and (5)
					Sub-Total	4,940,076	4,886,471	6,480,000	1,539,924	

4. INFORMATION ON OUR GROUP (Cont'd)

Registered Owner/Beneficial Owner No.	Address/Title Identification	Description/Existing Use	Approximate Age of Building/Tenure/Approximate Land Area/Approximate Built-up Area (sqf)	Restriction/Interest/Encumbrances	Date of Issuance of CF	Audited NBV as at 31.12.2013 (RM)	Audited NBV as at 31.12.2014 (RM)	Market Value/Date of Valuation/Method of Valuation (RM)	Revaluation Surplus as at 31.12.2013 (RM)	Reference
4.	Ikhmas Jaya Lot 299, Jalan Segenting, 42500 Teluk Panglima Garang, Selangor Darul Ehsan/ Geran Mukim 1465, Lot 299, Locality of Batu 12, Jalan Telok-Jugra, Mukim of Teluk Panglima Garang, District of Kuala Langat and State of Selangor Darul Ehsan	A parcel of agriculture land zoned for industrial use/ Vacant	Not applicable/ Freehold/ 115,432/ Not applicable	None/ Charged twice to United Overseas Bank (Malaysia) Berhad	Not applicable	3,312,375	3,411,970	3,500,000/ 03.03.2014 and 01.06.2015/ Comparison Method	187,625	-
5.	Ikhmas Jaya Lot 4907, Jalan Segenting, Batu 11, Kuala Langat, 42500 Teluk Panglima Garang, Selangor Darul Ehsan/ Geran Mukim 1622, Lot 4907, Locality of Jalan Tanjong Duabelas, Mukim of Teluk Panglima Garang, District of Kuala Langat and State of Selangor Darul Ehsan	A parcel of industrial land/ Storage and maintenance area for construction materials and equipment	Not applicable/ Freehold/ 275,340/ Not applicable	None/ Charged four times to AmBank (M) Berhad	Not applicable	2,151,605	2,159,873	11,500,000/ 03.03.2014 and 01.06.2015/ Comparison Method and Investment Method	9,348,395	Notes (2) and (5)
6.	Ikhmas Jaya No. 63, Jalan SS15/8A, SS15, 47500 Subang Jaya, Selangor Darul Ehsan/ Geran 298818, Lot No. 8254, Bandar Subang Jaya (formerly known as HSD 9434, PT No. 4073, Mukim of Damansara), District of Petaling and State of Selangor Darul Ehsan	An intermediate 4-storey terrace shop/ office/ Rented to two (2) different tenants	30/ Freehold/ 1,755/ 6,696	None/ Charged to Southern Bank Berhad and CIMB Bank Berhad	1984	907,170	897,906	3,600,000/ 07.03.2014 and 01.06.2015/ Cost Method and Investment Method	2,692,830	Notes (3) and (5)
Sub-Total						6,371,150	6,469,749	18,600,000	12,228,850	

4. INFORMATION ON OUR GROUP (Cont'd)

Registered Owner/ Beneficial Owner No. Owner	Address/ Title Identification	Description/ Existing Use	Approximate Age of Building/ Tenure/ Approximate Land Area/ Approximate Built-up Area (sqft)	Restriction in Interest/ Encumbrances	Date of Issuance of CF	Audited NEV as at 31.12.2013 (RM)	Audited NEV as at 31.12.2014 (RM)	Market Value/ Date of Valuation/ Method of Valuation (RM)	Revaluation Surplus as at 31.12.2013 Reference
7. Setiausaha Kerajaan/ Selangor/ Ikhmas Jaya	No. 2, Jalan Kerayong 5, Taman Sri Kerayong, Off Jalan Kapar, 42200 Kapar, Selangor Darul Ehsan/ PM 3742, Lot No. 31071, Seksyen 1, Locality of Kapar, Pekan Kapar, (formerly known as HS(M) 16307, Lot No. PT 20591, Mukim of Kapar), District of Klang and State of Selangor Darul Ehsan	A corner single-storey terrace house/ Vacant	13 years/ Leasehold 99 years (expiring on 17.01.2094)/ 3,025/ 1,053	This land shall not be transferred, charged or leased without the prior approval from the state authority/ None	19.11.2001	14,934	14,934	160,000/ 04.03.2014 and 01.06.2015/ Cost Method	145,066
					Sub-Total	14,934	14,934	160,000	145,066
					Total	11,326,160	11,371,154	25,240,000	13,913,840
									Note (6)

Notes:-

(1) The party walls between the shop/ office have been demolished to provide mutual access. The staircase at shop/ office no. 35 has been removed and the side verandah at shop/ office no. 35 has been enclosed. The first floor's flat roof area and second floor's void area between shop/ office nos. 35 and 37 have been enclosed. This is also the same with the area between shop/ office nos. 37 and 39. On behalf of Ikhmas Jaya, Arkitek Mustapha Kamal Sdn Bhd (the "Architect") had on 4 July 2014 submitted an application to Majlis Bandaraya Petaling Jaya ("MBPJ") to obtain approval for the extension and renovation ("MBPJ Approval"). As at the LPD, the MBPJ Approval is pending and is anticipated to be obtained twelve (12) months from the date of the submission of the revised building plan incorporating all the necessary amendments required by MBPJ ("MBPJ Submission for Final Approval"). The MBPJ Submission for Final Approval is pending as we are waiting for the inspection from the Fire Department in order to obtain the release/ approval letter from the Fire Department. Please refer to Section 3.1.12 of this Prospectus for our next course of action in the event that the MBPJ Approval is not obtained and for the risk associated with the aforementioned non-compliance. Please refer to note (5) in Section 4.14.2 of this Prospectus in relation to the undertakings provided by us on the MBPJ Approval.

(2) Erected on the site are two (2) open sided structure and ancillary buildings as well as cabin containers which are generally constructed of metal framework, metal deck roof and metal cladding wall. A building plan approval has yet to be obtained. On behalf of Ikhmas Jaya, Jururancang Nazreomar as the Planning Consultant had on 28 August 2014 submitted an application to Majlis Daerah Kuala Langat ("MDKL") to obtain planning approval for the temporary building used as a storage area for construction materials ("MDKL Approval"). MDKL had on 16 October 2014 granted a conditional approval for the temporary building plan ("MDKL Conditional Approval") and further issued a separate letter dated 24 October 2014 setting out detailed conditions ("MDKL Letter of Conditions"). Thereafter, we expect to submit the revised building plan incorporating all the necessary amendment(s), as required by MDKL ("MDKL Submission for Final Approval"). We have obtained the approval from Indah Water Konsortium on 28 April 2015. Further, Tenaga Nasional Berhad ("TNB") has via its letter dated 6 April 2015 stated that it has no objection for the construction of the temporary building/ store subject to the construction of a substation. We have via our letters dated 12 April 2015 and 18 May 2015, appealed to the TNB for the waiver of such requirement which were not successful. We are in the midst of submitting another appeal to TNB to waive the said condition in view that the MDKL Approval is for the temporary building/ store. As at the LPD, the MDKL Approval is pending and is anticipated to be obtained within twelve (12) months from the MDKL Submission for Final Approval. Please refer to Section 3.1.12 of this Prospectus for our next course of action in the event that the MDKL Approval is not obtained and for the risk associated with the aforementioned non-compliance.

4. INFORMATION ON OUR GROUP (Cont'd)

- (3) The front wall of the first floor has been repositioned to accommodate an opened sitting area. On behalf of Ikhmas Jaya, the Architect had on 4 July 2014 submitted an application to Majelis Perbandaran Subang Jaya ("MPSJ") to obtain approval for the extension and renovation ("MPSJ Approval"). MPSJ had on 26 August 2014 granted a conditional approval for the building plan ("MPSJ Conditional Approval"). In reply, the Architect had on 16 October 2014 submitted the revised building plan incorporating all the necessary amendments as required by MPSJ ("MPSJ Submission for Final Approval"). The approval of the Fire Department was obtained on 12 May 2015 ("Bomba Approval"). On behalf of Ikhmas Jaya, the Architect had on 26 May 2015 notified MPSJ that the Bomba Approval had been obtained and the conditions for the MPSJ Submission for Final Approval have been fulfilled. Further, on behalf of Ikhmas Jaya, the Architect had on 27 May 2015, made payment to MPSJ for an extension of ten (10) months from 18 August 2015 to 18 May 2016 to obtain the MPSJ Approval ("MPSJ Approval Extension"). As at the LPD, the MPSJ Approval is pending and is anticipated to be obtained within twelve (12) months from the MPSJ Approval Extension. If our Group is not able to obtain the MPSJ Approval, we intend to request and negotiate with the tenants occupying the property to shift in order for rectification works to be performed on the property until all the relevant laws, regulations, rules and requirements are fully complied with. Save for the loss of rental income to our Group, there is no associated risk that could affect our business and operations in connection to the aforementioned non-compliance. Please refer to note (5) in Section 4.14.2 of this Prospectus in relation to the undertakings provided by us on the MPSJ Approval.
- (4) We do not have a copy of the CF and has requested for a copy from MPSJ. As indicated by the MPSJ in its letter dated 26 May 2014, the CF had been issued in 1984 by Majelis Perbandaran Petaling Jaya and MPSJ is unable to provide us with a copy of the CF as MPSJ does not have a copy in its records as the CF was issued more than 29 years ago ("MPSJ Letter"). Therefore, the exact date of the issuance of the CF cannot be determined other than the year of the issuance as stated in the aforementioned MPSJ Letter.
- (5) We had on 31 October 2014 provided the SC the following undertakings:-
- (a) To obtain the MBPJ Approval and MPSJ Approval in accordance with the expected timeframe as disclosed in note (1) and note (3) in Section 4.14.2 of this Prospectus respectively;
 - (b) To update the SC when the MBPJ Approval and MPSJ Approval are obtained; and
 - (c) To provide all necessary disclosures with regards to the status of the applications to MBPJ and MPSJ to obtain the MBPJ Approval and MPSJ Approval respectively in our annual report.
- (6) The revaluation surplus has not and will not be incorporated in the financial statements of the Ikhmas Jaya.

Please refer to Section 12 of this Prospectus for the Valuation Certificates prepared by the Independent Registered Valuers in relation to the valuation of the properties.

[THE REST OF THIS PAGE IS INTENTIONALLY LEFT BLANK]

4. INFORMATION ON OUR GROUP (Cont'd)

4.14.3 Investment Properties

Registered Owner/ Beneficial Owner	Address/ Title Identification	Description	Approximate Age of Building/ Approximate Built-up Area (sqft)	Restriction in Interest/ Encumbrances	Date of Issuance of CF	Audited NBV as at 31.12.2014 (RM)
1. Solid Promenade Sdn Bhd/ Ikhmas Jaya	8-1, Level 8, Damai 88, No.79, Jalan Damai, off Jalan Ampang, 55100 Kuala Lumpur, Wilayah Persekutuan/ Parcel No.: 8-1 within storey No. 8 held under Master Title GRN76768, Lot 20003, Seksyen 88 (formerly known as GRN12914, Lot 83, Seksyen 0088), Bandar and District of Kuala Lumpur, State of Wilayah Persekutuan	Service Apartment	Not applicable/ Freehold/ 1,215	None/ Charged to United Overseas Bank (Malaysia) Bhd	^(b) Not applicable	1,078,616
2. Solid Promenade Sdn Bhd/ Ikhmas Jaya	9-1, Level 9, Damai 88, No.79, Jalan Damai, off Jalan Ampang, 55100 Kuala Lumpur, Wilayah Persekutuan/ Parcel No.: 9-1 within storey No. 9 held under Master Title GRN76768, Lot 20003, Seksyen 88 (formerly known as GRN12914, Lot 83, Seksyen 0088), Bandar and District of Kuala Lumpur, State of Wilayah Persekutuan ^(b)	Service Apartment	Not applicable/ Freehold/ 1,040	None/ Charged to United Overseas Bank (Malaysia) Bhd	^(b) Not applicable	1,083,541
3. Jelas Puri Sdn Bhd/ Ikhmas Jaya	Unit No. A-16-2, Floor 16, Block A, Azure Residences @ Paradigm Pj, Jalan SS7/26A, Kelana Jaya, 47301 Petaling Jaya, Selangor Darul Ehsan Parent Lot (P.T.) 5167, held under Master Title No. HSD 280412, Seksyen 40, Bandar Petaling Jaya, Daerah Petaling, Negeri Selangor.	Service Apartment	Not applicable/ Leasehold 99 years (expiring on 9 February 2111)/ 766.18	The land can be transferred, leased or charged upon the approval of the state authority/ Land charged to Malaysian Trustees Berhad and RHB Islamic Bank Berhad	^(b) Not applicable	^(b) Not applicable
Total						2,162,157

Notes:-

- (i) As at the LPD, there are no existing use to the properties, no CF issued and no valuation carried out on these properties as they are currently under construction.
- (ii) As disclosed in Section 13.5(a) of this Prospectus.
- (iii) The sale and purchase agreement was signed on 29 January 2015 as disclosed in item (2) in Section 4.14.8 and Section 13.5(i) of this Prospectus.